

UNCONTROLLED DOCUMENT

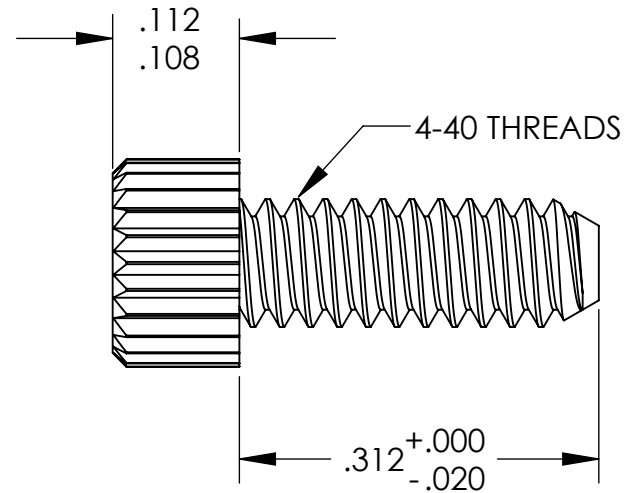
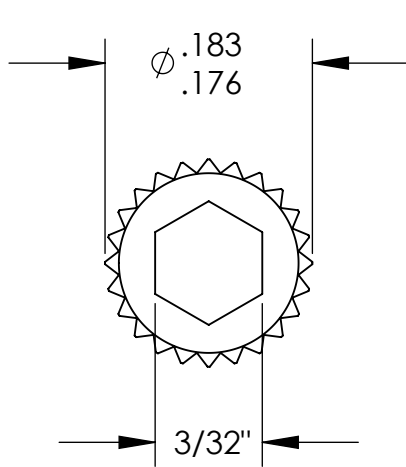

NOTES:
.051 MINIMUM KEY ENGAGEMENT

TOLERANCES UNLESS NOTED

- ±.005 ON DIMENSIONS THRU .625
- ±.008 ON DIMENSIONS .626 THRU 1.000
- ±.010 ON DIMENSIONS 1.001 THRU 1.500
- ±.015 ON DIMENSIONS LARGER THAN 1.500
- ±.015 ON FRACTIONAL DIMENSIONS

**WE RESERVE THE RIGHT
TO DISCONTINUE ITEMS,
CHANGE SPECIFICATIONS
OR DESIGN AT ANY TIME
WITHOUT NOTICE AND
WITHOUT INCURRING
ANY OBLIGATIONS**

PROPERTY OF		
MICRO PLASTICS INC.		
CATALOG DRAWING HEX SOCKET CAP MACHINE SCREW MICRO P/N 3404400031 DWG. # 3404400031 FILE SERVER\ENG\WEB		
MATERIAL:		6/6 NYLON
DATE	SCALE	JDD
	6:1	