



**OVER  
17,000  
PRODUCTS**

# WHY ESSENTRA COMPONENTS?

We combine the expertise and flexibility of a manufacturer with the service and range of a distributor.



**65+**  
YEARS  
solving  
customer  
challenges



Operations in  
**29 COUNTRIES**  
worldwide



**45,000**  
products  
available



**80 MILLION**  
parts produced  
each week

## THIS IS ESSENTRA COMPONENTS

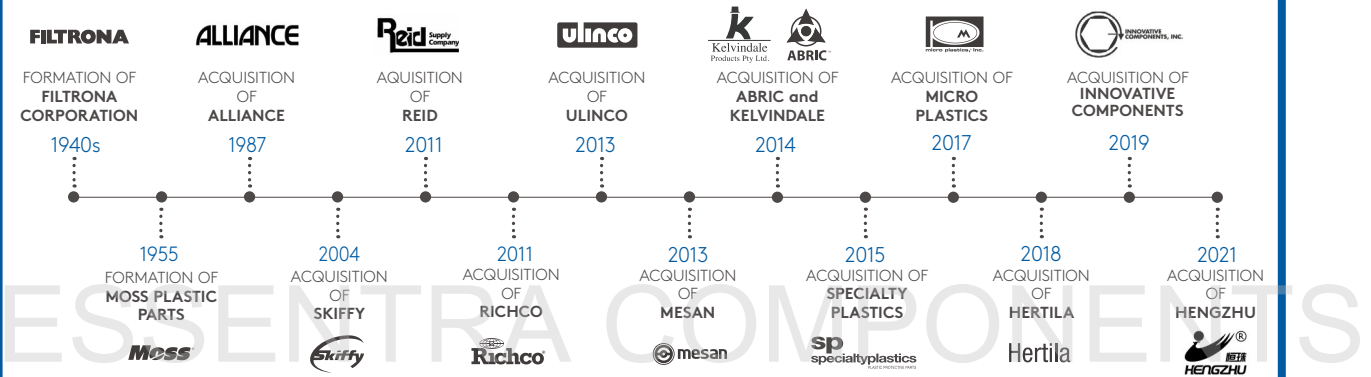

**2500**  
EMPLOYEES  
ACROSS THE  
WORLD

**29**  
LOCAL LANGUAGE  
E-COMMERCE  
SITES

**AMERS**  
7 manufacturing  
sites

**EMEA**  
4 manufacturing  
sites

**APAC**  
3 manufacturing  
sites



### STABILITY & GLOBAL GROWTH

- 2021 - £301.7M revenue
- £56.9M operating profit

**34**  
DISTRIBUTION  
CENTRES

**40**  
SALES  
AND SERVICE  
LOCATIONS

# HASSLE FREE SERVICE

EQUIPMENT MANUFACTURERS • AUTOMOTIVE • ELECTRICAL MANUFACTURERS  
• TRANSPORT/LOGISTICS • POS/RETAIL

**1 BILLION**  
PARTS  
IN STOCK

**70%**  
OF TOP 100 GLOBAL  
MANUFACTURERS

**90%**  
OF ELECTRONICS  
MANUFACTURERS

**100%**  
OF TOP 15 GLOBAL  
AUTO TIER 1 SUPPLIERS

**17**  
PRODUCT  
RANGES

**5.6**  
MILLION  
CUSTOM SOLUTIONS  
PRODUCED  
TO DATE

SHIPPING OVER  
**17,000**  
ORDERS EACH WEEK

PROCESSING  
**1.8M**  
ORDER LINES A YEAR

SENDING OVER  
**300,000**  
SAMPLE ORDERS  
TO CUSTOMERS

**80,000**  
CUSTOMERS  
WORLDWIDE



CAPS  
& PLUGS



ACCESS  
HARDWARE



CABLE  
MANAGEMENT



FASTENERS

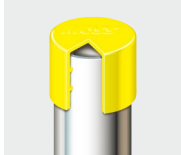

PIPE & FLANGE  
AND HOSE  
PROTECTION



CIRCUIT BOARD  
HARDWARE



HIGH  
TEMPERATURE  
MASKING



KNOBS,  
HANDLES  
& GRIPS



**FREE**  
CAD



**FREE**  
SAMPLES



**FREE**  
DESPATCH



**CUSTOM**  
SOLUTIONS

## WORKING FOR A BETTER LIFE

All principal manufacturing sites are **ISO 14001** accredited.

**ISO 14001**  
ACCREDITED



**SUPPORT** the creation of prosperous, educated, sustainable and healthy **COMMUNITIES** wherever we operate.



**DEVELOPED TARGETED PROGRAMMES** often involving commercial sponsorship and significant **EMPLOYEE ENGAGEMENT.**



**79%**  
EMPLOYEE  
ENGAGEMENT

# NEW PRODUCTS AND EXPANDED LINES

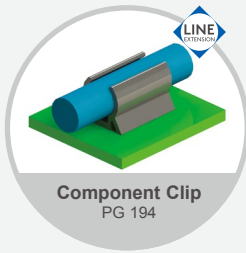
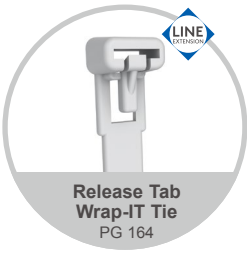
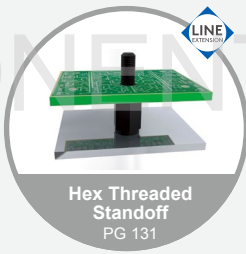
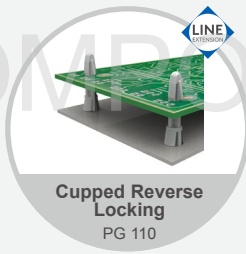
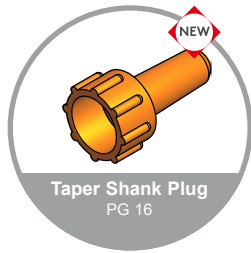
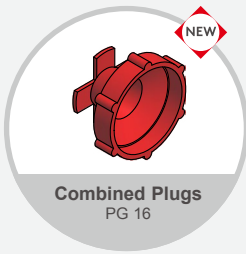

# NEW PRODUCTS AND EXPANDED LINES

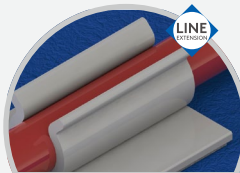

**U Style Clamp on Adhesive Base**  
PG 224



**Street Hole Plug**  
PG 256



**Domed Blanking Plugs**  
PG 259



**Body Plugs IP67**  
PG 261

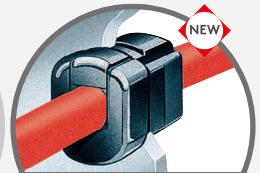

**Strained Relief Bushes**  
PG 263

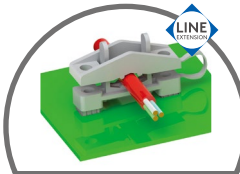

**Hinged Locking Clamp**  
PG 266



**Spacer Column Expanded**  
PG 341



**Slotted Hex Head Screw**  
PG 345

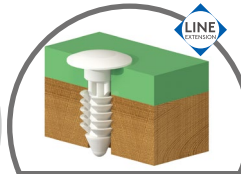

**Pawl Lock**  
PG 364

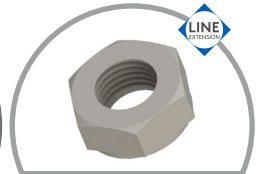

**Hex Nut**  
PG 368



**Cylinder Cam Locks**  
PG 396



**Quarter Turn Locks**  
PG 400



**Quarter Turn Lock - Knob**  
PG 407



**Clip On Quarter Turn**  
PG 407



**Mini Quarter Turn Wing Knob**  
PG 409



**Quarter Turn Knob**  
PG 409



**Mini Quarter Turn**  
PG 414



**T & L Quarter Turn Blind Latch**  
PG 421



**IP65 T Handle Heavy Duty Lock**  
PG 426



**Sliding Lock**  
PG 429



**Swing Handle Lock**  
PG 432



**Crank Lock**  
PG 436



**Expansion Lock**  
PG 436



**Raised Trigger Handle Latches**  
PG 442



**Fixed Compression Latches**  
PG 447

# NEW PRODUCTS AND EXPANDED LINES

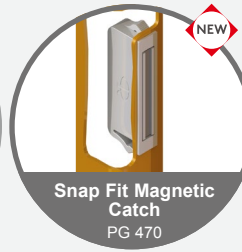
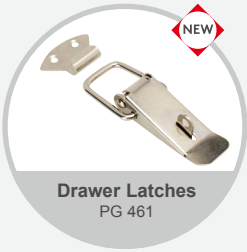

# NEW PRODUCTS AND EXPANDED LINES



# CONTENTS

01-40



CAPS AND PLUGS

41-60



HYDRAULIC AND  
PNEUMATIC PROTECTION

61-68



PIPE AND FLANGE PROTECTION

69-88



HIGH TEMPERATURE MASKING

89-140



CIRCUIT BOARD HARDWARE

141-152



CARD GUIDES AND PULLERS

153-158

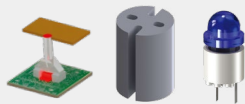

LED HARDWARE

159-274

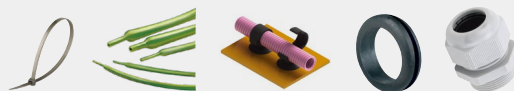

CABLE TIES AND  
CABLE MANAGEMENT

275-306



EMI SUPPRESSION  
FERRITE CORES

307-319



FIBRE MANAGEMENT



# CONTENTS

## FAN ACCESSORIES



320-328

## FASTENERS AND FIXINGS



329-394

## LOCKS, LATCHES, CATCHES AND HINGES



395-525

## GASKETING AND ENCLOSURE ACCESSORIES

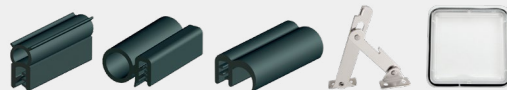

526-541

## SLIDE BEARINGS AND VIBRATION MOUNTS



542-551

## HANDLES, KNOBS AND POSITIONING COMPONENTS



552-595

## FEET & CASTORS



596-623

## TUBE INSERTS, CONNECTORS AND FERRULES

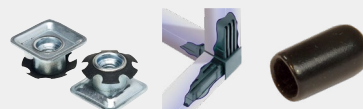

624-643

## FURNITURE FITTINGS

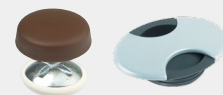

644-651

# Fast-Find Index

## Caps and Plugs



p.3



p.8



p.10



p.11



p.13



p.15



p.16



p.16



p.17



p.18



p.18



p.19



p.22



p.23

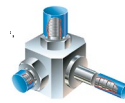

p.24



p.25



p.26



p.27



p.29



p.34



p.35



p.36



p.37



p.40

## Hydraulic and Pneumatic Protection



p.43



p.44



p.45



p.47



p.48



p.49



p.50



p.51



p.52



p.53



p.53



p.54



p.55



p.56

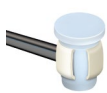

p.56



p.60

## Pipe and Flange Protection



p.63



p.65



p.66



p.67



p.68



p.68

## High Temperature Masking



p.71



p.74



p.75



p.76



p.78



p.81



p.83



p.83



p.84

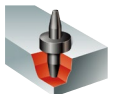

p.85



p.86



p.86



p.87



p.87

## Circuit Board Hardware



p.91



p.91



p.95



p.96

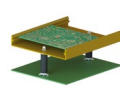

p.98



p.99



p.100



p.103

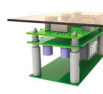

p.104



p.109

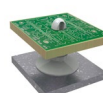

p.113



p.114



p.114



p.115



p.116

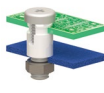

p.116



p.117



p.118

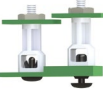

p.118



p.124



p.125



p.128



p.130



p.131



p.132

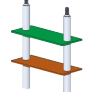

p.134



p.136

## Card Guide and Pullers



p.143



## LED Hardware

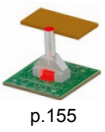

p.145 p.146 p.146 p.147 p.147 p.149 p.150 p.151 p.155

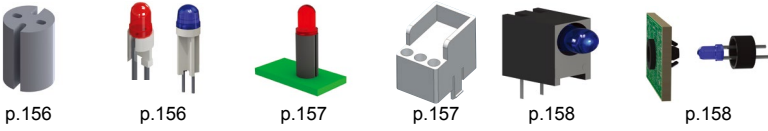

## Cable Ties and Cable Management



p.156 p.156 p.157 p.157 p.158 p.158 p.161 p.166

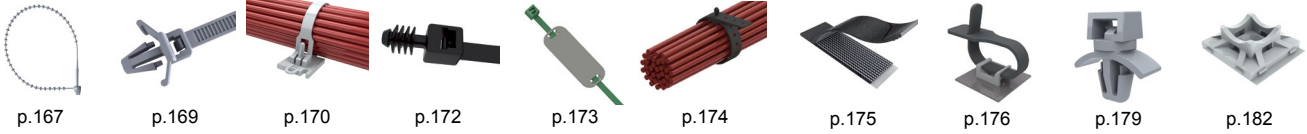

p.167 p.169 p.170 p.172 p.173 p.174 p.175 p.176 p.179 p.182

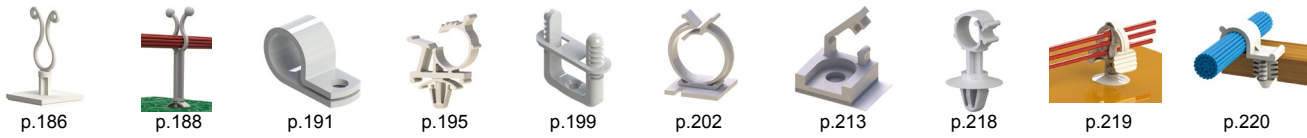

p.186 p.188 p.191 p.195 p.199 p.202 p.213 p.218 p.219 p.220



p.221 p.225 p.238 p.239 p.240 p.241 p.246 p.247 p.250 p.250



p.251 p.253 p.253 p.256 p.264 p.265 p.269 p.270 p.273

## EMI Suppression Ferrite Cores



p.278 p.279 p.282 p.290 p.298 p.300 p.304 p.305 p.306

## Fibre Management



p.309 p.310 p.311 p.312 p.313 p.314 p.317 p.318 p.319

## Fan Accessories



p.323 p.324 p.325 p.326 p.328

## Fasteners and Fixings



p.331

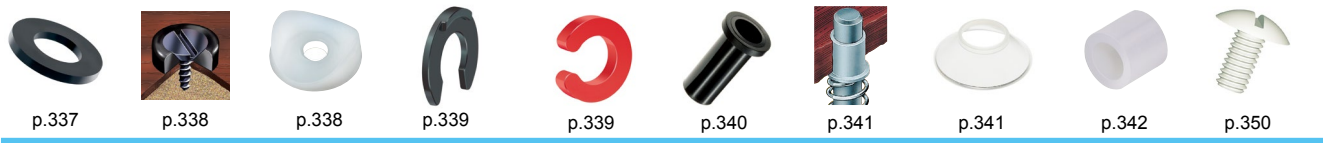

p.337 p.338 p.338 p.339 p.339 p.340 p.341 p.341 p.342 p.350

# Fast-Find Index

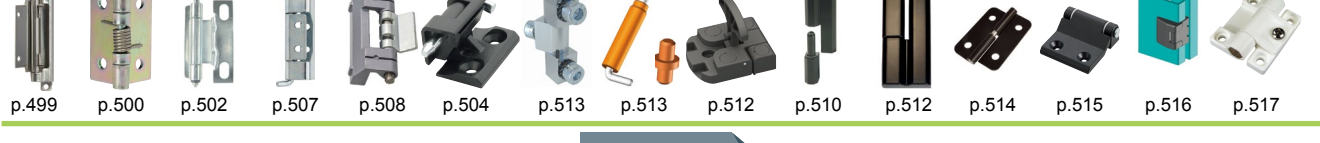
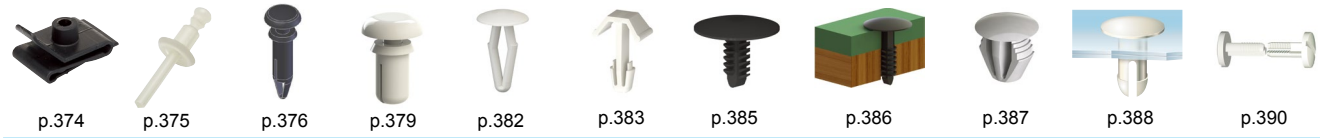

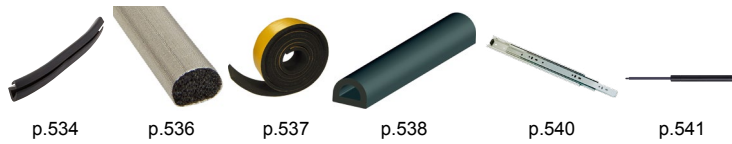

p.534 p.536 p.537 p.538 p.540 p.541

## Slide Bearings and Vibration Mounts



p.544 p.546 p.547



p.548 p.548 p.549 p.550 p.551

## Handles, Knobs and Positioning Components



p.554 p.555 p.557 p.558 p.560



p.562 p.562 p.564 p.566 p.566 p.567 p.568 p.570 p.572 p.577 p.582 p.579 p.580



p.583 p.585 p.585 p.586 p.587 p.588 p.593 p.590 p.592 p.592 p.592 p.592 p.594

## Feet and Castors



p.598 p.599 p.600 p.603 p.604 p.605 p.606 p.607



p.608 p.609 p.610 p.610 p.611 p.612 p.613 p.614 p.614 p.616

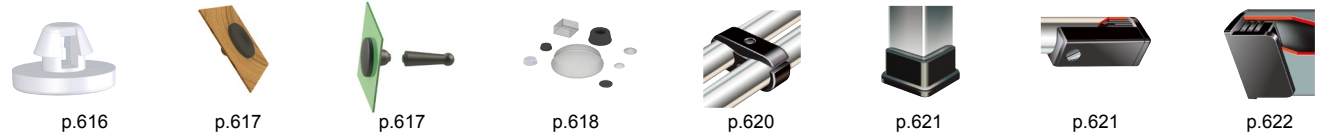

p.616 p.617 p.617 p.618 p.620 p.621 p.621 p.622



p.623

## Tube Inserts, Connectors and Ferrules



p.626 p.627 p.628 p.629 p.630 p.631 p.631



p.632 p.636 p.637 p.639 p.639 p.639 p.640 p.641 p.641 p.642

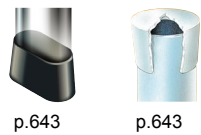

p.643 p.643

## Furniture Fittings



p.646 p.647 p.647 p.648 p.649 p.649

## FEET - KEEP IT LEVEL

Ideal for machinery and conveyor belts, our range of Pressed Bolt Down Feet includes an asymmetrical base shape to improve clearance when situating feet close to walls or walkways.

We also have a wide range of levelling feet for you, offering a choice of finishes for all applications and load-bearing requirements.

## STAY ON TRACK WITH OUR CASTORS

Ensure your project is moving in the right direction with over 450 industry led Castor solutions.



Please refer to the back cover of this catalogue for contact details of Essentra Components Asia Pacific offices.



# FEET AND CASTOR

**Machinery Feet**

**598-601**



**Adjustable Feet**

**602-606**



**Furniture Feet**

**607**



**Self-Adhesive, Screw-On Feet and Buffers**

**608-618**



**Tiltserts, Buffers and Glides**

**619-620**



**Saddle and Insert Feet**

**621-622**

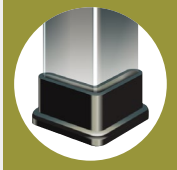
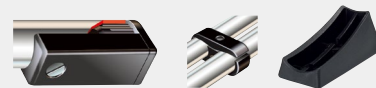

**Furniture Castors**

**623**



SR 1569

## Premium Machinery Mounting Feet

Plain Base with Stainless Steel or ENP Mild Steel Stud

- Stud manufactured from solid hexagon bar by rolling process ensuring both accuracy and strength of thread
- Nylon base offers high-load capacity, chemical resistance and stability during temperature change
- 10mm diameter mounting hole



### Plain Black Nylon Base

Part Number		Thread Size	Dimensions (mm)		Approximate Load Capacity (kg)	Std Pack Qty
Stainless Steel Stud	ENP Mild Steel Stud		D	L		
462402	-	M8	55	60	400	48
462403	-	M10	55	75	500	48
462404	462415	M12	55	75	600	24
462405	462416	M12	55	125	600	24
-	462417	M12	55	150	600	8
462406	462418	M12	70	75	1000	24
-	462419	M12	70	150	1000	8
462407	-	M12	70	125	1000	8
462408	462420	M16	70	75	1500	8
462409	462421	M16	70	150	1500	4
462410	-	M16	70	200	1500	4
462411	462422	M16	100	75	2000	4
-	462423	M16	100	100	2000	4
462412	462424	M16	100	150	2000	4
-	462425	M16	100	200	2000	4
462413	462426	M20	100	150	2000	4
462414	-	M24	100	200	2000	4

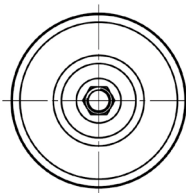
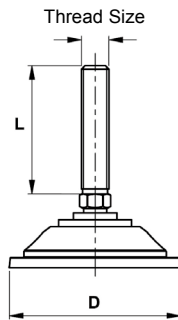
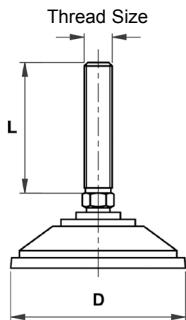

Plain Base

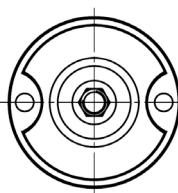

Bolt-Down Base

### Bolt-Down Black Nylon Base

Part Number		Thread Size	Dimensions (mm)		Approximate Load Capacity (kg)	Std Pack Qty
Stainless Steel Stud	ENP Mild Steel Stud		D	L		
462427	462433	M12	100	75	1000	8
462428	462434	M12	100	125	1000	8
-	462435	M12	100	150	1000	8
462429	462436	M16	100	75	2000	8
462430	462437	M16	100	150	2000	8
-	462438	M16	100	200	2000	8
462431	462439	M20	100	150	2000	4
462432	-	M20	100	200	2000	4
-	462440	M24	100	150	2000	4

### Stainless Steel Base

Part Number		Thread Size	Dimensions (mm)		Approximate Load Capacity (kg)	Std Pack Qty
Stainless Steel Stud	ENP Mild Steel Stud		D	L		
462441	-	M8	38	60	450	24
462442	-	M10	38	75	600	24
462443	-	M12	55	75	1500	8
462444	-	M12	55	125	1500	8
462445	-	M12	55	160	1500	8
462446	-	M16	70	75	2000	4
462447	462451	M16	70	150	2000	4
462448	-	M16	70	200	2000	4
462449	462453	M20	100	150	3000	4



## SR 1545

### Standard Machine Feet

#### Nylon Base with Zinc Plated Steel Bolt

- Ideal for mounting machinery or conveyers
- High load bearing capacity
- Maximum recommended load; 900Kg
- 20° Articulation



#### Bolt Down Nylon Base

Part Number	Thread Size	Dimensions (mm)		Std Pack Qty
		Foot Dia	Stud Length	
1254547	M8	60	80	40
1254548	M10	60	70	40
1254549	M10	60	125	40
1254553	M12	80	100	24
1254550	M12	80	150	24
1254534	M16	80	100	20
1254535	M16	80	150	20
1254536	M12	100	125	20
1287122	M16	100	100	20
1287123	M16	100	200	20
1234172	M16	120	150	20
1287124	M16	120	200	20
1254537	M20	120	150	48
1254538	M24	120	200	40

#### Non-Slip Feet

- Suitable for SR 1545 feet
- Provides extra friction to prevent slippage



#### Plain Nylon Base

Part Number	Thread Size	Dimensions (mm)		Std Pack Qty
		Foot Dia	Stud Length	
1254519	M8	40	25	40
1254520	M8	40	40	40
1254539	M8	40	80	40
1254521	M8	50	40	40
1254540	M8	50	60	40
1254541	M8	50	80	40
1254522	M10	50	45	40
1254542	M10	50	70	40
1254543	M10	50	90	40
1254523	M10	60	45	40
1254544	M10	60	70	40
1254545	M10	60	125	40
1254555	M12	60	66	24
1254551	M12	60	80	24
1254554	M12	60	100	24
1254524	M12	60	125	24
1287125	M12	60	150	24
1254552	M12	80	66	24
1254556	M12	80	100	24
1254525	M12	80	125	24
1254546	M12	80	150	24
1254526	M16	80	66	20
1254527	M16	80	100	20
1254528	M16	80	150	20
1287126	M16	100	66	20
1287127	M16	100	100	20
1287128	M16	100	125	20
1287129	M16	100	150	20
1287130	M16	100	200	20
1234171	M16	120	150	20
1287131	M16	120	200	20
1254529	M20	120	125	12
1254530	M20	120	150	12
1254531	M20	120	200	12
1254532	M24	120	200	12
1254533	M24	120	250	12

#### Non-slip Feet

Part Number		Dimensions (mm)		Std Pack Qty
For Plain Base	For Bolt-Down Base	Foot Dia		
1254557	-	40		40
1254558	-	50		40
1254559	1254563	60		24
1254560	1254564	80		20
1254561	1254565	100		20
1254562	1254566	120		12

# Machinery Feet

SR 5440

## Pressed Steel Bolt Down Feet

Galvanised Steel, NBR 80 Rubber

- High load capacity
- 8° articulation
- 4 x 12.5mm fixing holes
- With or without rubber pad for base
- Ideal for conveyors and machines

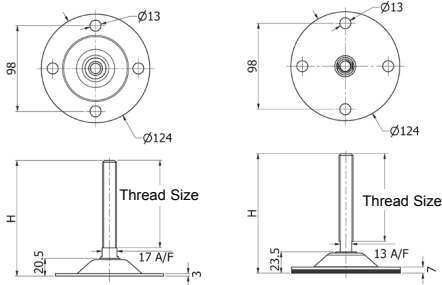

Standard



Rubber Pad Version



Part Number		Thread Size	Dimensions (mm) H	Maximum Static Load N	Std Pack Qty
Standard	Rubber Pad Version				
493684	493685	M16 x 100	134	20000	2
493688	493689	M20 x 100	134	20000	2

SR 5443

## Vibration Dampening Machine Feet - Bolt Down

Base: Pressed stainless steel type 303 with inset Nitrile rubber core

Stud: Stainless steel type 303

- 7° Articulation
- Bolt down
- Designed to absorb vibration
- High adhesion to floor
- Application: Machinery

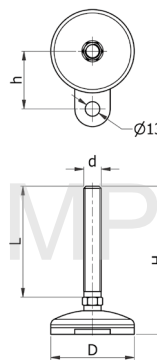

Part Number	Dimensions (mm)					Max Loading (kg)	Std Pack Qty
	d	L	H	D	h		
493715	M16	150	183	75	52	750	4
493716	M20	150	183	75	52	750	4

SR 5711

## Anti-Vibration Machine Mounts

Cast Iron Bearing Plate

Nitrile Rubber Moulding

- The foot holds in place as the thread is tightened
- The unique design enables height adjustment whilst maintaining a totally sealed vibration absorbing base
- Single part base, cast iron bearing plate with a nitrile rubber surround
- Shore rubber hardness 80
- All bolts are fine pitch

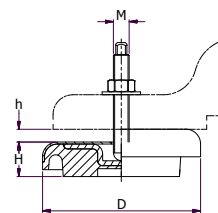

Part Number	Dimensions (mm)				Static Load per mount (kg)	Std Pack Qty
	Bolt (M)	Foot Dia (D)	Foot Height (H)	Adjust Height (h)		
550115*	M10x80	80	25	8	170	4
550116	M12x100	120	32	12	1200	1
550117	M16x120	160	35	12	3500	1

\* Rubber Shore Hardness 60

## SR 5700

### Low-Profile Bolt Down Levelling Foot

#### Mild Steel

- Load capacities ranging from 300kg - 3750kg
- 20° Articulation
- Stainless Steel 303 or Mild Steel
- With a Hygienic seal that provides a flexible cover over the ball and socket arrangement
- Bolt down hole for secure fixing

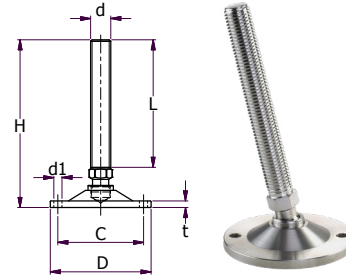

Part Number	Dimensions (mm)							Max Load Capacity (kg)	Std Pack Qty	
	Mild Steel	Thread Size (d)	Thread Length (L)	Foot Dia (D)	Bolt Down Centre (C)	Height (H)	Flange Thickness (t)			Hole Dia (d1)
550101	M8	60	50	40	40	82	4	5.5	300	12
550102	M10	75	50	40	40	97	4	5.5	500	12
550103	M12	150	60	50	50	175	5	5.5	1250	8
550104	M16	150	80	68	68	181	6	6.5	1750	4
550105	M20	150	100	82	82	189	6.5	9	2500	4
550106	M24	200	120	100	100	256	7.5	11	3750	4

## SR 5701

### Light Duty Fixed Stud Levelling Foot

#### Stainless Steel Base with Nitrile Rubber Pad

#### Stainless Steel Thread

- Stainless Steel 303
- Fixed Foot
- Low profile

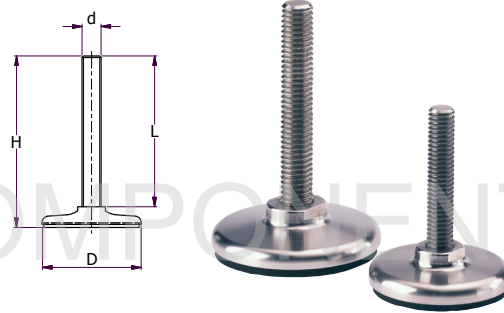

Part Number	Dimensions (mm)				Max Load Capacity (kg)	Std Pack Qty
	Thread Size (d)	Foot Dia (D)	Stud Length (L)	Height (H)		
550107	M8	40	60	72	450	12
550108	M10	40	60	72	600	12
550109	M10	50	80	94	600	12
550110	M12	50	50	65	750	8
550111	M12	50	75	90	750	8

## SR 5701

### Heavy Duty Fixed Stud Levelling Foot

#### Stainless Steel Base with Nitrile Rubber Pad

#### Stainless Steel Thread

- Stainless Steel 303
- Fixed Foot
- Low profile

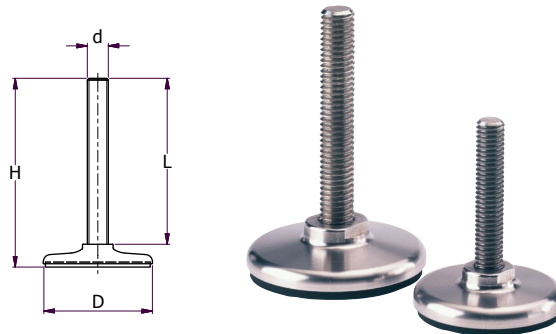

Part Number	Dimensions (mm)				Max Load Capacity (kg)	Std Pack Qty
	Thread Size (d)	Foot Dia (D)	Stud Length (L)	Height (H)		
550112	M12	60	125	140	1250	4
550113	M16	80	150	171	2000	4
550114	M20	120	200	224	3000	4

# Adjustable Feet

SR 1572

## Standard Non-Articulating Adjustable Feet

Black Polypropylene

- Outer-Hex Slotted Head for adjustment
- POZI socket in base for easy adjustment



25mm Diameter Foot

Part Number		Stud Length	Std Pack Qty	
M6	M8		M6	M8
466121	-	20	500	-
-	466122	25	-	500
-	466123	40	-	350
-	466124	55	-	250
-	466125	70	-	200
-	466126	100	-	150

30mm Diameter Foot

Part Number		Stud Length	Std Pack Qty	
M8	M10		M8	M10
466127	466132	25	400	300
466128	466133	40	300	200
466129	466134	55	200	100
466130	466135	70	150	100
466131	466136	100	100	50

38mm Diameter Foot

Part Number			Stud Length	Std Pack Qty		
M8	M10	M12		M8	M10	M12
466137	466142	466147	25	400	300	200
466138	466143	466148	40	300	200	150
466139	466144	466149	55	200	100	150
466140	466145	466150	70	150	100	100
466141	466146	466151	100	100	50	50

48mm Diameter Foot

Part Number			Stud Length	Std Pack Qty		
M8	M10	M12		M8	M10	M12
466152	466157	466162	25	300	200	150
466153	466158	466163	40	200	150	100
466154	466159	466164	55	150	100	100
466155	466160	466165	70	150	100	200
466156	466161	466166	100	100	50	50

SR 1572

## Standard Articulating Adjustable Feet

Black Polypropylene

- Allow adjustment under load with base remaining stationary
- Outer-Hex Slotted Head for adjustment
- POZI socket in base for rapid assembly



25mm Diameter Foot

Part Number		Stud Length	Std Pack Qty	
M6	M8		M6	M8
466212	-	20	500	-
-	466167	25	-	500
-	466168	40	-	350
-	466169	55	-	250
-	466170	70	-	200
-	466171	100	-	150

30mm Diameter Foot

Part Number		Stud Length	Std Pack Qty	
M8	M10		M6	M8
466172	466177	25	400	300
466173	466178	40	300	200
466174	466179	55	200	100
466175	466180	70	150	100
466176	466181	100	100	50

38mm Diameter Foot

Part Number			Stud Length	Std Pack Qty		
M8	M10	M12		M8	M10	M12
466182	466187	466192	25	400	300	200
466183	466188	466193	40	300	200	150
466184	466189	466194	55	200	100	150
466185	466190	466195	70	150	100	100
466186	466191	466196	100	100	50	50

48mm Diameter Foot

Part Number			Stud Length	Std Pack Qty		
M8	M10	M12		M8	M10	M12
466197	466202	466207	25	300	200	150
466198	466203	466208	40	200	150	100
466199	466204	466209	55	150	100	100
466200	466205	466210	70	150	100	50
466201	466206	466211	100	100	50	50

SR 1572

## Non-Articulating Adjustable Feet

Black Polypropylene

- Use alone or with threaded inserts



Part Number			Dimensions (mm)		Std Pack Qty		
M8	M10	M12	Foot Dia	Stud Length	M8	M10	M12
497505	-	-	25	15	750	-	-
497509	-	-	25	25	500	-	-
465523	-	-	30	50	400	-	-
497506	-	-	34	38	500	-	-
497507	-	-	38	25	500	-	-
497508	-	-	38	38	500	-	-
-	466586	-	38	40	-	250	-
465528	-	-	38	50	250	225	-
462315	465524	-	38	60	250	200	-
-	465525	-	38	70	-	175	-
-	465530	-	38	100	150	125	-
-	466588	-	48	30	-	200	-
460810	466591	-	48	40	400	350	-
-	466592	-	48	50	-	150	-
-	465531	-	48	60	350	150	-
-	465532	-	48	70	-	125	-
-	465533	-	48	100	-	100	-
-	465534	-	48	120	-	150	-
-	465520	-	58	50	-	125	100

ESSENTRA COMPONENTS

SR 5439

## Industrial Articulated Stainless Steel Feet

Black Nylon Base, 304 Stainless Steel Thread

- 30° articulation
- Ideal for catering and food machinery



Part Number	Thread Size	Dimensions (mm)			Maximum Static Load N	Std Pack Qty
		D	A	H		
493670	M8x50	40	27	77	10000	24
493671	M8x75	40	27	102	10000	24
493672	M10x75	40	27	102	10000	24
493673	M12x75	40	27	102	10000	24
493674	M10x100	40	27	127	10000	24
493675	M12x100	40	27	127	10000	24
493676	M10x75	65	33	108	11000	8
493677	M12x75	65	33	108	11000	8
493678	M10x100	65	33	133	11000	8
493679	M12x100	65	33	133	11000	8
493680	M16x100	65	37	137	15000	8
493681	M20x100	65	37	137	15000	8
493682	M16x150	65	37	187	15000	8
493683	M20x150	65	37	187	15000	8

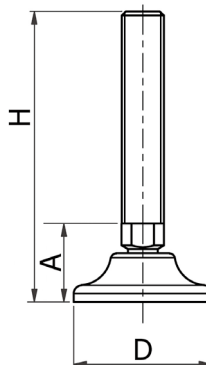

# Adjustable Feet

SR 1573

## One-Piece Adjustable Feet

Black Nylon

- Rugged, durable and heavy duty
- Resist lateral stress
- One-piece threaded insert and height adjuster

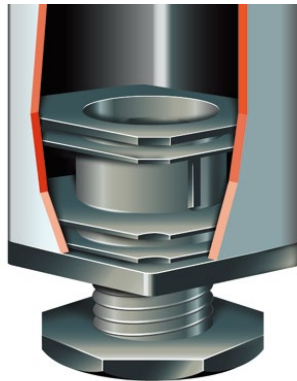
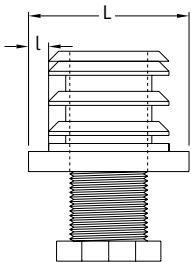

### Square

Part Number	Dimensions (mm)			Axial load kg approx.	Std Pack Qty
	L	l (gauge)	Thread		
465494	20 x 20	1.5-2.0	M10 x 25	100	100
465495	25 x 25	1.5-2.0	M16 x 25	150	100
465496	30 x 30	1.5-2.0	M22 x 25	300	100
465489	35 x 35	1.5-2.0	M22 x 25	300	100
465490	40 x 40	1.5-2.0	M22 x 25	300	100
465491	45 x 45	1.5-2.0	M30 x 30	300	100
465492	50 x 50	1.5-2.0	M30 x 30	300	100

### Round

Part Number	Dimensions (mm)			Axial load kg approx.	Std Pack Qty
	L	l (gauge)	Thread		
465486	32	1.5-2.0	M22 x 25	300	100
465487	35	1.5-2.0	M22 x 25	300	100
465493	45	1.5-2.0	M30 x 30	300	100

SR 1575

## Adjustable Tilt Glides

Black Polypropylene

- Bright zinc-plated steel tilt ball and stud
- Ideal for angled applications
- Can be adjusted for use on uneven floor surfaces
- Ideal for use with SR1570 & SR1571 threaded inserts



ESSENTRA COMPONENTS

Part Number	Thread Size	Dimensions (mm)		Std Pack Qty
		Foot Dia	Stud Length	
462183	M6	25.0	25.0	750
462184	M6	32.5	25.0	500
110728	M8	25.0	12.0	100
110732	M8	25.0	25.0	100
110729	M8	32.0	12.0	100
110733	M8	32.0	25.0	100
110730	M8	38.0	12.0	100
110734	M8	38.0	25.0	100
110731	M8	47.5	12.0	100
110735	M8	47.5	25.0	100
110736	M10	25.0	15.0	100
110740	M10	25.0	38.0	100
110744	M10	25.0	50.0	100
110737	M10	32.0	15.0	100
110741	M10	32.0	38.0	100
110745	M10	32.0	50.0	100
110738	M10	38.0	15.0	100
110742	M10	38.0	38.0	100
110746	M10	38.0	50.0	100
110739	M10	47.5	15.0	100
110743	M10	47.5	38.0	100
110747	M10	47.5	50.0	100

SR 1572

**Low-Profile Adjustable Feet**

Black Nylon or Polyethylene

- Robust, sturdy and durable
- Zinc-plated steel stud
- Ideal for uneven surfaces



SR 1564

**All-metal Height Adjusters**

BZP Steel

- Articulating stud

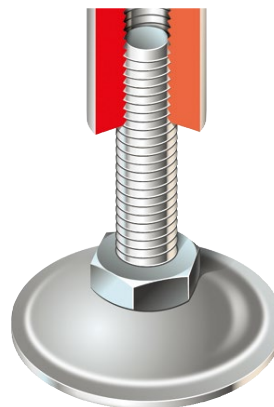

Part Number	Thread Size	Dimensions (mm)		Std Pack Qty
		Foot Dia	Stud Length	
463786	M10	46	40	200
463787	M10	46	60	175

ESSENTRA COMPONENTS

Part Number	Dimensions (mm)		Thread Size	Std Pack Qty
	Foot Dia	Stud Length		
498651*	20	20	M6	2000
498653*	20	50	M6	1000
498655*	25	25	M6	1000
498654*	20	16	M8	1000
465329†	25	25	M8	1000
498656*	25	37	M8	500
498657*	32	20	M8	600
465330†	35	25	M8	500
465331†	25	35	M10	500
498658*	32	25	M10	500
465328†	35	35	M10	500
499810*	44	20	M10	250

\* Polyethylene

† Nylon

SR 1578

**Smooth-Based Adjustable Glides**

Black Polyethylene

- Smooth chrome-coloured steel base offers excellent sliding movement
- Zinc-plated steel stud
- Ideal for use on carpeted floors



Part Number	Thread Size	Dimensions (mm)		Std Pack Qty
		Foot Dia	Stud Length	
465353	M8	30	25	500
465351	M8	40	25	250
465349	M10	30	25	500
465357	M10	40	25	250

# Adjustable Feet

SR 1574

## Chrome-Capped Adjustable Feet

Black Polyethylene

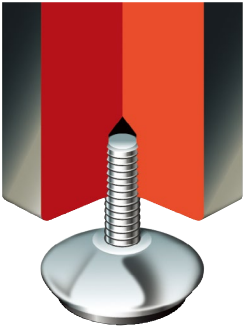

- Attractive chrome metal covershell
- Non-tilt design provides extra stability
- Ideal for uneven surfaces
- Protect floor surface from abrasion

Part Number	Thread Size	Dimensions (mm)		Std Pack Qty
		Foot Dia	Stud Length	
465347	M6	20	10	1000
465346	M8	25	20	500
465352	M8	30	20	250
465355	M8	35	20	250
465356	M8	40	25	250
465345	M10	25	20	250
465350	M10	30	20	250
465358*	M10	40	40	250
465354*	M10	40	60	200
465359**	M10	40	25	250

\* Small degree of tilt - loose swivelling adjustable nut (17mm a/f).

\*\* Fixed hexagonal adjustable nut (10mm a/f).

SR 1574

## Chrome-Capped Low Profile Adjustable Feet

Natural Nylon

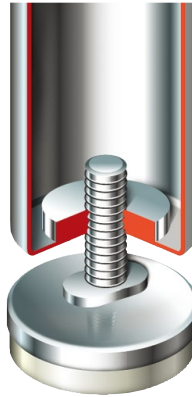

- Attractive chrome metal covershell
- Bright zinc-plated steel stud
- Ideal for uneven surfaces

Part Number	Thread Size	Dimensions (mm)		Std Pack Qty
		Foot Dia	Stud Length	
RWA25M0820	M8	25	20	500
RWA35M0820	M8	35	20	250
RWA45M0820	M8	45	20	250
RWB50M0820*	M8	50	20	250
RWA45M1045	M10	45	45	250

\* Style variation, cap covers entire base.

SR 5726

## Rubber Fixed Foot

- Steel Thread
- Fixed Screw
- Rubber foot absorbs vibrations
- Anti-slip

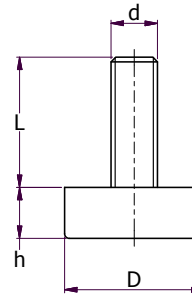

Part Number	Dimensions (mm)				Std Pack Qty
	Base Diameter D	Base Height h	Thread Size	Stud Length (mm)	
499421	30	11	M6	18	50
499424	30	11	M8	38	50
499430	35	12	M6	18	50
499431	35	12	M6	38	50
499432	35	12	M8	18	50
499433	35	12	M8	38	50
499434	35	12	M10	18	50
499435	35	12	M10	38	50
499436	35	12	M12	18	50
499437	35	12	M12	38	50



SR 6440

## Gripneck Feet

Nylon Base, Galvanised Steel Stem

- Gripneck Stem for quick fitting
- Smooth base for easy movement
- Type 4 has a hollow base

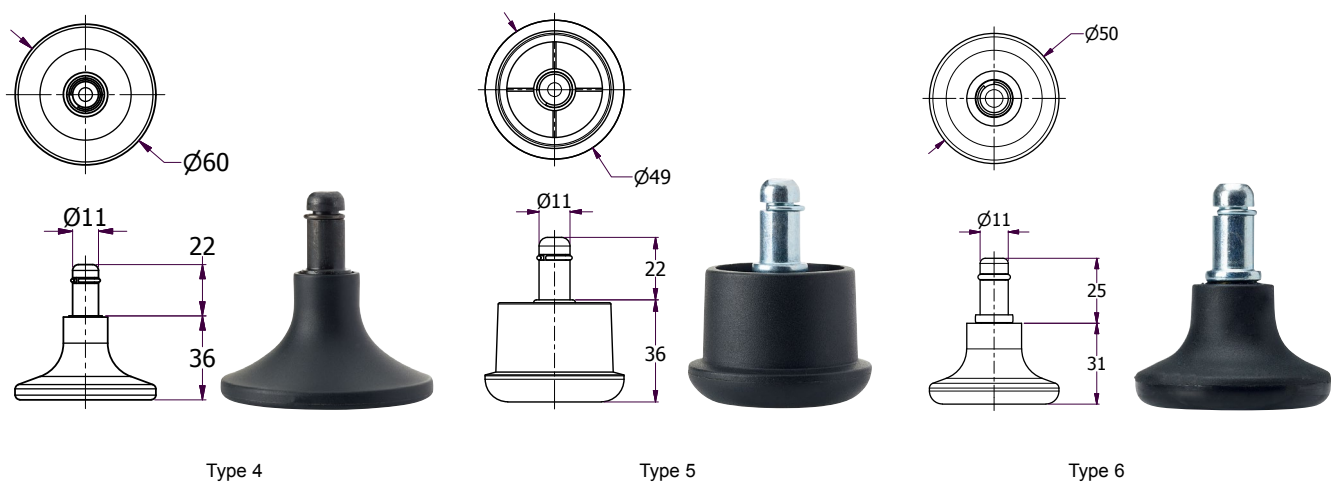
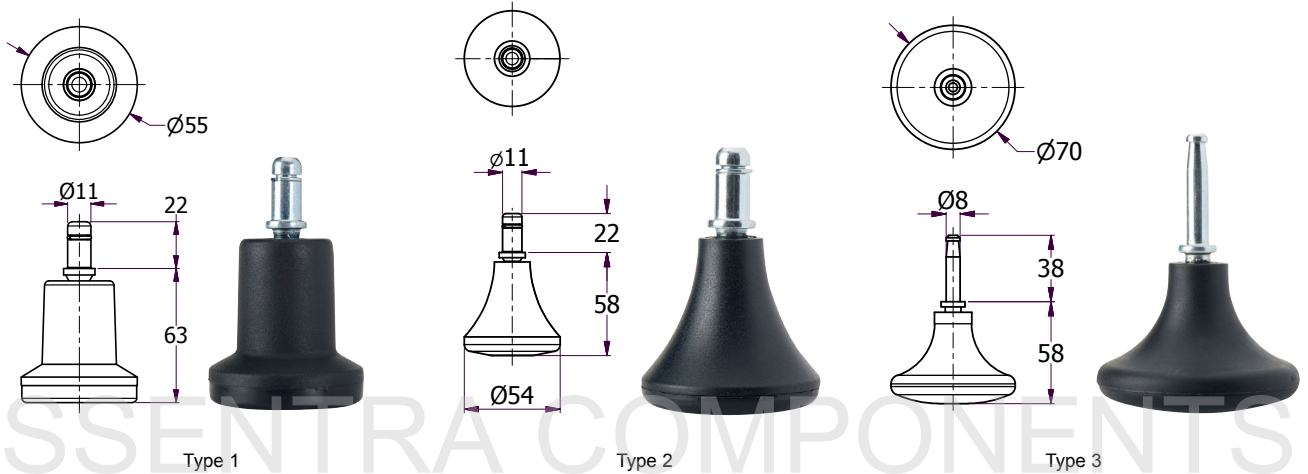

Part Number	Type	Load Bearing (kg)	Std Pack Qty
551066	1	55	200
551062	2	50	200
551063	3	50	200
551064	4	50	200
551065	5	55	200
551061	6	50	200

# Self-Adhesive, Screw-On Feet and Bumpers

SR 1590

## Screw-On Feet

Black LDPE, TPR or Natural Rubber

- Ideal for wooden cabinets, equipment enclosures, free-standing electrical/electronic equipment etc
- Fit with screws (not supplied)
- TPR is recommended for excellent slip resistance

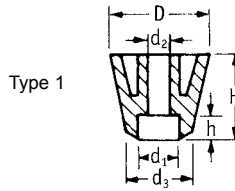
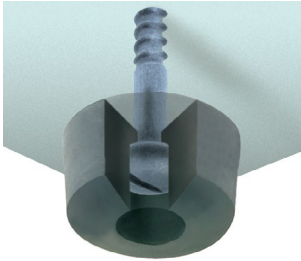

Type 1

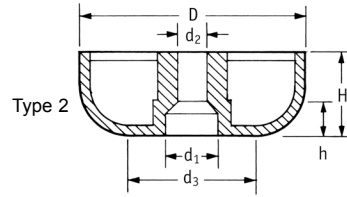

Type 2

Part Number			Type	Dimensions (mm)						Std Pack Qty
LDPE	TPR	Neoprene		H	D	d3	d1	d2	h	
60470	15129		1	7.1	15.9	13.5	7.9	3.2	4.0	10000
12477	15130		1	9.5	16.4	16.4	6.4	4.0	5.6	10000
		SOF-15140	1	9.5	17.5	-	8.0	4.0	5.2	100
60785	15124		1	11.3	19.3	18.0	7.5	3.2	7.9	5000
51607	15125		1	11.9	19.8	18.2	9.5	4.7	6.3	5000
		SOF-15111	1	15.5	19.0	12.7	8.0	4.0	4.8	100
50842	15111		1	15.9	19.0	12.7	7.9	4.0	4.8	5000
50954	15127		1	18.2	18.5	17.5	8.5	4.8	7.9	2000
		SOF-15126	1	25.0	22.5	12.7	8.7	4.0	14.5	100
50769	15126		1	25.4	22.2	12.7	8.7	4.0	14.3	3000
50701	15140		2	9.5	17.5	17.5	7.9	4.0	5.2	3500
49098	-		2	16.0	45.0	30.0	10.5	5.0	10.0	3000
49099	-		2	19.0	55.0	40.0	10.5	5.0	12.0	750

Part Number		Type	Dimensions (mm)						Std Pack Qty
Natural Rubber			H	D	d3	d1	d2	h	
462177	2	9.0	16.0	13.0	7.0	3.0	4.0	425	
462178	2	8.0	19.0	16.0	7.0	3.0	6.0	425	
462179	2	8.0	22.0	19.0	10.0	3.0	6.0	300	
462180	2	9.0	25.0	20.0	13.5	5.0	6.0	250	
462181	2	15.0	27.0	20.0	10.0	6.0	10.0	250	
462182	2	23.0	35.0	30.0	9.0	6.0	5.0	450	

Contact of Natural Rubber

SOF

## Screw on Feet

Black, Neoprene Rubber, RMS-190

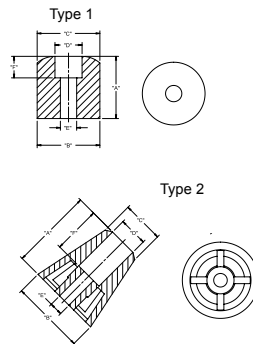

Part Number	Dimensions (mm)						Type	Std Pack Qty
	"A"	Ø "B"	Ø "C" REF.	Ø "D"	Ø "E"	"F"		
1339688	7.1	15.9	13.8	8	3.2	4	1	100
1339686	11.5	19.1	18	10.2	5	6.35	1	100
SOF-15127	18.35	18.5	-	8	4.8	6.35	1	100

Contact of Natural Rubber

P0007

## Screw Mounting Feet

Black PVC

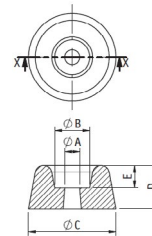

Part Number	Dimensions (mm)					Std Pack Qty
	A	B	C	D	E	
048150011407	3.2	6	15	7.5	4	100
048200011407	4.3	8	20	10	5	100
048250011407	4.3	10	25	12.5	6.5	100
048300011407	5.3	12	30	15	7.5	50
066020011407	4.2	9	19.5	23	7.5	100
066025011407	5.2	11	24.5	25	7.5	100

## FF Fast Foot

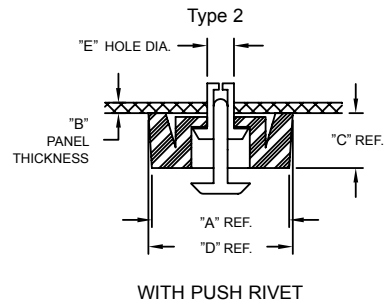
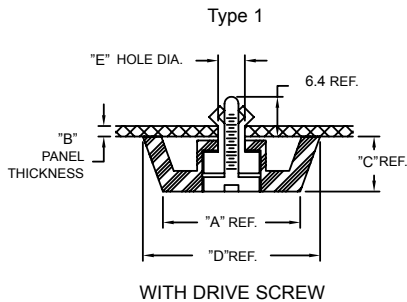

Part Number	Foot Material	Rivet/Screw Material	Grommet Material	Dimensions (mm)					Type	Std Pack Qty
				"A" REF.	"B" Thickness Range	"C" REF.	"D" REF.	"E" Hole Ø		
FF-001B	TPE, RMS-76	POM, RMS-39	Nylon 6, RMS-52	20	1 - 2.3	14	24	5 - 5.1	1	100
FF-004B	TPE, RMS-76	POM, RMS-39	Nylon 6, RMS-52	18	1 - 2.3	10	10	5 - 5.1	1	100
FF-003-P3X5.5B	TPE, RMS-42	Nylon 6, RMS-52	Nylon 6, RMS-52	13.5	0.8 - 1.8	5.5	14.2	3.1 - 3.2	2	100
FF-005-P4X5B	TPE, RMS-76	Nylon 6, RMS-52	Nylon 6, RMS-52	20	0.8 - 1.8	4.2	21	4.1 - 4.2	2	100
FF-005-P4X6B	TPE, RMS-76	Nylon 6, RMS-52	Nylon 6, RMS-52	20	1.8 - 2.8	4.2	21	4.1 - 4.2	2	100
FF-005-P4X7B	TPE, RMS-76	Nylon 6, RMS-52	Nylon 6, RMS-52	20	2.9 - 3.7	4.2	21	4.1 - 4.2	2	100
FF-005-P4X8B	TPE, RMS-76	Nylon 6, RMS-52	Nylon 6, RMS-52	20	3.8 - 4.8	4.2	21	4.1 - 4.2	2	100
FF-006-P4X6B	TPE, RMS-76	Nylon 6, RMS-52	Nylon 6, RMS-52	14	0.6 - 1	6	15	4.1 - 4.2	2	100
FF-006-P4X7B	TPE, RMS-76	Nylon 6, RMS-52	Nylon 6, RMS-52	14	1 - 2	6	15	4.1 - 4.2	2	100
FF-006-P4X8B	TPE, RMS-76	Nylon 6, RMS-52	Nylon 6, RMS-52	14	2 - 3.1	6	15	4.1 - 4.2	2	100
FF-006-P5X6.5B	TPE, RMS-76	Nylon 6, RMS-52	Nylon 6, RMS-52	14	0.8 - 1.2	6	15	5.1 - 5.2	2	100
FF-006-P5X7.5B	TPE, RMS-76	Nylon 6, RMS-52	Nylon 6, RMS-52	14	1.3 - 2.3	6	15	5.1 - 5.2	2	100
FF-008-P4X6B	TPE, RMS-76	Nylon 6, RMS-52	Nylon 6, RMS-52	20	0.8 - 1.8	6	21	4.1 - 4.2	2	100
FF-008-P4X7B	TPE, RMS-76	Nylon 6, RMS-52	Nylon 6, RMS-52	20	1.9 - 2.8	6	21	4.1 - 4.2	2	100
FF-008-P4X8B	TPE, RMS-76	Nylon 6, RMS-52	Nylon 6, RMS-52	20	2.9 - 4	6	21	4.1 - 4.2	2	100
FF-009-P4X6B	TPE, RMS-76	Nylon 6, RMS-52	Nylon 6, RMS-52	20	0 - 0.8	8	21	4.1 - 4.2	2	100
FF-009-P4X7B	TPE, RMS-76	Nylon 6, RMS-52	Nylon 6, RMS-52	20	0.8 - 2	8	21	4.1 - 4.2	2	100
FF-009-P4X8B	TPE, RMS-76	Nylon 6, RMS-52	Nylon 6, RMS-52	20	2.1 - 3	8	21	4.1 - 4.2	2	100
FF-010-P4X7B	TPE, RMS-76	Nylon 6, RMS-52	Nylon 6, RMS-52	14	1 - 2	9	15	4.1 - 4.2	2	100
FF-010-P4X8B	TPE, RMS-76	Nylon 6, RMS-52	Nylon 6, RMS-52	14	2 - 3.1	9	15	4.1 - 4.2	2	100
FF-13-P3.5X4.5B	TPE, RMS-76	Nylon 6, RMS-52	Nylon 6, RMS-52	10	0.5 - 1.2	4	10.8	3.6 - 3.7	2	100
FF-13-P3.5X5.5B	TPE, RMS-76	Nylon 6, RMS-52	Nylon 6, RMS-52	10	1.2 - 2	4	10.8	3.6 - 3.7	2	100
FF-13-P3.5X6.0B	TPE, RMS-76	Nylon 6, RMS-52	Nylon 6, RMS-52	10	1.5 - 2.2	4	10.8	3.6 - 3.7	2	100
FF-13-P3.5X7.0B	TPE, RMS-76	Nylon 6, RMS-52	Nylon 6, RMS-52	10	2.5 - 3.2	4	10.8	3.6 - 3.7	2	100

# Self-Adhesive, Screw-On Feet and Bumpers

SR 1592

## Rivet Feet

Black Polypropylene/Elastomer

- Two-piece construction comes pre-assembled
- Insert pin to fix the foot into the panel

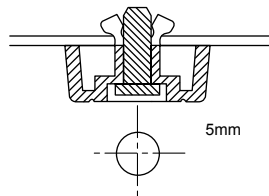
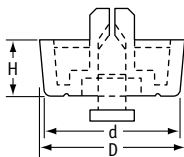

Part Number	Dimensions (mm)			Hole Diameter (mm)	Panel Thickness (mm)	Type	Std Pack Qty
	d	D	H				
Hard							
SFF-125-A4	18	20.0	15	7.9-8.0	0.8-1.8	1	200
SFF-124-A4	18	20.0	12	8.0-8.1	0.5-1.2	2	200
FF-026-M40	18	20.0	18	8.0-8.1	0.5-1.2	2	200

SFF

## Soft Fast Foot

Black, Foot: TPE, 86 Shore A, RMS-42;  
Pin: Polypropylene, RMS-126

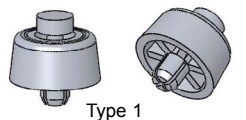

Type 1

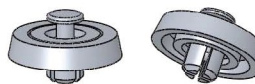

Type 2

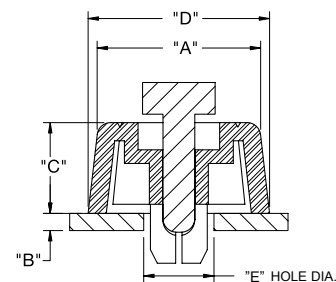
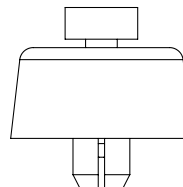

Part Number	Recommended Mounting Hole	Recommended Panel Thickness	Dimensions (mm)			Type	Std Pack Qty
			"A" Ø	"C" Ø	"D" Ø		
SFF-018	7.75	0.8 - 1.5	18	10	20	1	100
SFF-021	7.75	5 - 8	20	6	21	1	100
SFF-023	7.75	0.8 - 1.5	23	5	25	2	100
SFF-028	7.75	0.8 - 1.5	18	15	20	1	100

SR 6449

## Insert Foot

PVC

- Black or Natural
- Prevents sliding and reduces vibration
- Easy mounting through simple design

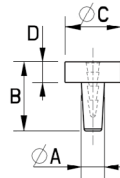

Type 1

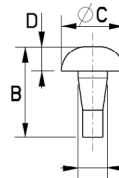

Type 2

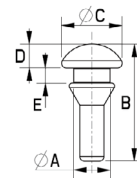

Type 3



Part Number	Colour	Recommended Panel Thickness	Dimensions (mm)					Type	Std Pack Qty
			A	B	C	D	E		
049080011407	Black	-	3	10	8	3	-	1	100
049120011407	Black	-	4	10	12	3	-	1	100
049130011407	Black	-	5	13	13	3	-	1	100
049160011407	Black	-	5	10	16	4	-	1	100
049100000007	Natural	-	4.2	13	9	3.5	-	2	100
047060011407	Black	1.2	6	19.5	10	2.5	4	3	100

POF

## Push on Feet

Black, UL94 HB TPE, RMS-262

Type 1

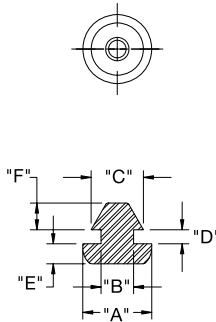

Type 2

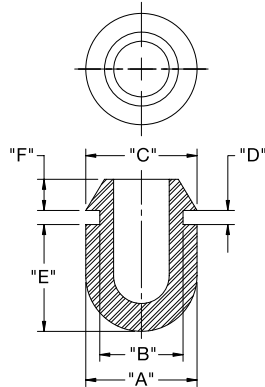

Type 3

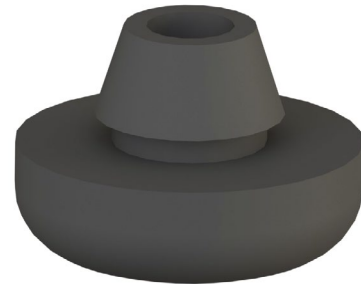
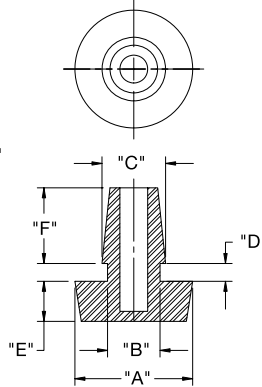

Part Number	Recommended Mounting Hole	Recommended Panel Thickness	Dimensions (mm)						Type	Std Pack Qty
			"A" Ø	"B" Ø	"C" Ø	"D"	"E"	"F" REF.		
POF-40022	3.7 - 3.8	3.2	7.9	3.2	4.4	3.3	1.5	4.1	1	100
POF-40048	4.5 - 4.6	1.5	7.9	3.7	6.1	1.6	2.3	3	1	100
POF-40059	9.5 - 9.6	1.5	12.7	9.5	12.7	1.6	12.2	3.6	2	100
POF-50185	6 - 6.1	1.9	13.4	6	7.3	2	4.6	8.6	3	100
POF-12664	7 - 7.1	1.2	15.7	7	8.6	1.3	5.1	4.1	3	100

# Self-Adhesive, Screw-On Feet and Bumpers

FBR

## Foot, Barbed Mount

Rivet: UL94 V2 Nylon 6/6, RMS-01

Foot: Black TPE, RMS-351

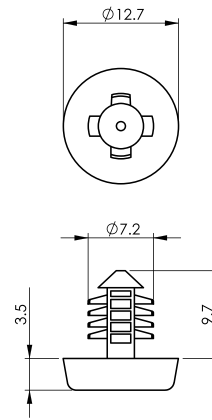

Part Number	Hole $\varnothing \pm 0.08$	Min. Panel Thickness	Std Pack Qty
FBR-1	6.8	10	1000

FSR

## Foot, Snap Rivet Mount

Rivet: UL94 V2 Nylon 6, RMS-52

Foot: Black TPE, RMS-351

ESSENTRA COMPONENTS

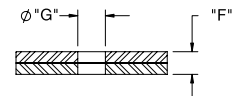
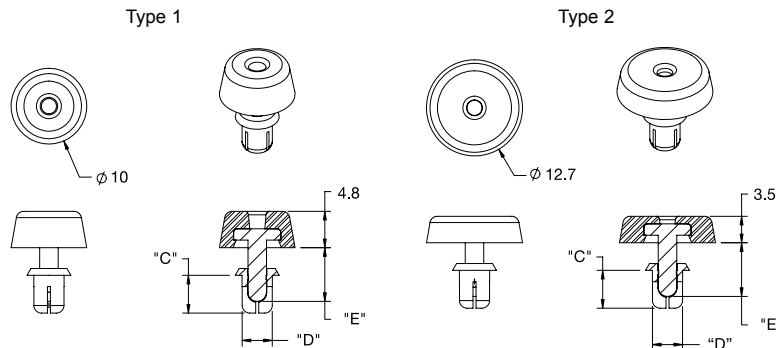

Part Number	Hole $\varnothing$ "G"	Dimensions (mm)				Type	Std Pack Qty
		Panel Thickness "F"	"C"	"D"	"E"		
FSR-1	3.6 - 3.7	1.2 - 2.1	3.5	3.5	5.1	1	1000
FSR-2	3.6 - 3.7	2.1 - 3	4.5	3.5	6.1	1	1000
FSR-3	4.1 - 4.2	2.5 - 3.5	5	4	7.1	1	1000
FSR-4	3.6 - 3.7	1.2 - 2.1	3.5	3.5	5.1	2	1000
FSR-5	3.6 - 3.7	2.1 - 3	4.5	3.5	6.1	2	1000
FSR-6	4.1 - 4.2	2.5 - 3.5	5	4	7.1	2	1000

## SR 1591

### Grommet Feet

Black PVC

- Ideal for housings and cases
- Easy to fit; simply push into punched or drilled holes



Part Number	Type	Dimensions (mm)							Std Pack Qty
		D	d <sub>1</sub>	d <sub>2</sub>	H	h <sub>1</sub>	h <sub>2</sub>	h <sub>3</sub>	
50680	1	19.0	13.1	12.0	6.5	0.8	3.2	-	10000
12493	1	15.4	9.8	12.7	7.0	1.6	2.7	-	10000
12494	1	19.0	12.8	15.9	7.5	1.6	3.2	-	3500
50493	2	10.3	4.5	2.2	7.6	1.6	2.0	-	5000
12664	2	15.8	6.8	4.0	9.7	1.5	5.0	-	10000
1347532	3	7.9	3.2	-	8.3	3.2	1.6	3.5	10000
1347527	3	7.9	3.7	-	7.0	1.6	2.4	3.0	10000
1347534*	4	12.5	9.5	-	17.0	1.6	12.0	3.5	5000
12495	5	10.9	6.9	-	12.8	0.7	8.1	-	10000
50185	6	12.0	6.0	5.8	15.2	2.1	4.6	-	10000
1347530	7	25.3	12.5	15.3	20.0	5.0	4.0	-	2000
15509	8	17.5	11.1	13.3	10.0	2.6	4.0	4.0	10000

\* Style variation on flanged section.

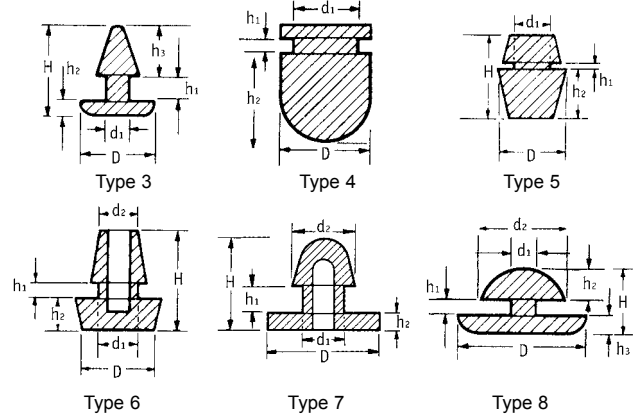
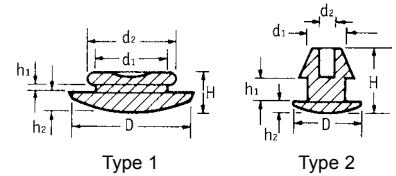

## SR 1461

### PTFE Glider Adhesive Fixing

- PTFE Base with adhesive backing
- Available in round, square and rectangular



Round

Square

Rectangular

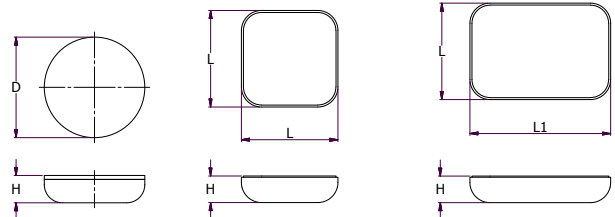

#### Round

Part Number	Dimensions (mm)		Std Pack Qty
	Diameter	Height	
499475	19	4.3	200
499477	25	6.7	200
499478	30	6.5	200
499479	40	6.3	200
499480	50	6.4	200

#### Square & Rectangular

Part Number	Dimensions (mm)			Std Pack Qty
	L	L1	Height	
499490	30	30	6.5	200
499494	40	40	7.0	200
499498	25	25	5.0	200
499496	50	50	6.5	200
499497	19	70	6.3	200
499492	24	100	6.3	200

# Self-Adhesive, Screw-On Feet and Bumpers

ASPR/ASPS

## Anti Slip Pads

Black, polyethylene foam, closed cells, with rubber based pressure sensitive adhesive

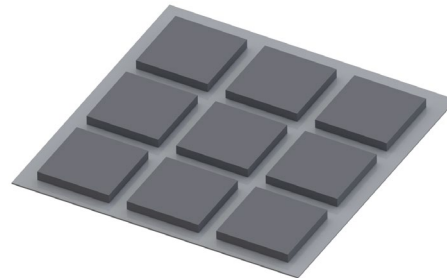

ASPR

ASPS

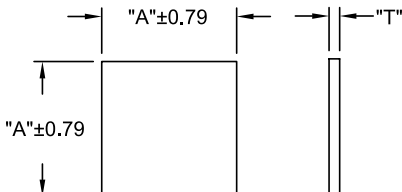
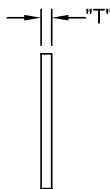
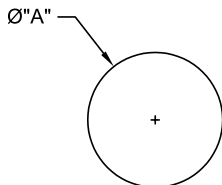

Part Number	Dimensions (mm)		Material	Std Pack Qty
	"A"	"T"		
ASPR-8-062	12.7	1.6	RMS-128	1000
ASPR-12-062	19.1	1.6	RMS-128	1000
ASPR-16-062	25.4	1.6	RMS-128	1000
ASPR-8-125	12.7	3.2	RMS-129	1000
ASPR-12-125	19.1	3.2	RMS-129	1000
ASPR-16-125	25.4	3.2	RMS-129	1000
ASPS-8-062	12.7	1.6	RMS-128	40/pad
ASPS-12-062	19.1	1.6	RMS-128	20/pad
ASPS-16-062	25.4	1.6	RMS-128	8/pad
ASPS-8-125	12.7	3.2	RMS-129	40/pad
ASPS-12-125	19.1	3.2	RMS-129	20/pad
ASPS-16-125	25.4	3.2	RMS-129	8/pad

SR 1577

## Stick-On Discs

Black Rubber

- Self-adhesive
- Suitable for smooth and dry surfaces
- Does not leave scuff marks when removed
- Slip-resistant



Part Number	Dimensions (mm)		Std Pack Qty
	Height	Diameter	
49093	1.5	10	1000
49094	1.5	20	1000
49095	1.5	30	1000
49096	1.5	40	500
49097	1.5	45	500



SVF

## Shock & Vibration Dampening Foot

SVF-1: TPE, 75 Shore A, RMS-158

SVF-2: TPE, 64 Shore A, RMS-384

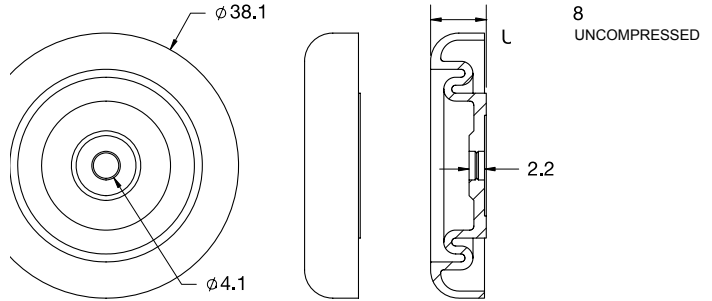

Part Number	Panel Thickness Range	Richco Snap Rivet Sold Separately		Std Pack Qty
		Use With		
SVF-1	0.3 - 1.3	SR-4050		400
SVF-1	1.3 - 2.3	SR-4060		400
SVF-1	2.3 - 3.3	SR-4070		400
SVF-1	3.3 - 4.3	SR-4080		400
SVF-2	0.3 - 1.3	SR-4050		400
SVF-2	1.3 - 2.3	SR-4060		400
SVF-2	2.3 - 3.3	SR-4070		400
SVF-2	3.3 - 4.3	SR-4080		400

BF

## Big Foot

Black, Foot material; UL94 HB ABS, RMS-114

Cushion material; Nylon Fiber, RMS-240

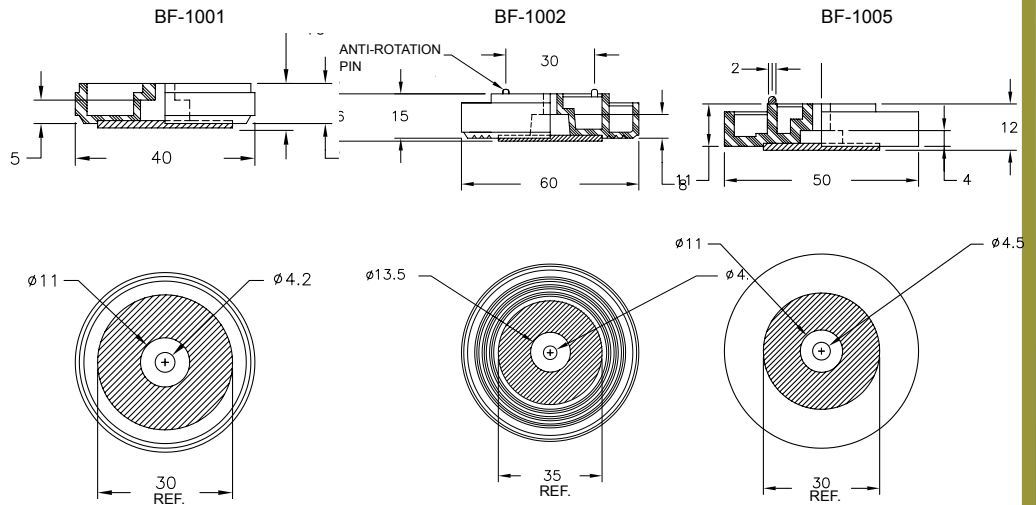

Part Number	Recommended Mounting Screw	Load Capacity
BF-1001	#8 or M4 Pan Head	10 kg
BF-1002	#8 or M4 Pan Head	10 kg
BF-1005	#8 or M4 Pan Head	10 kg

TB

## Threaded Insert Bumper

Black, Rubber Bumper: IIR, Shore 40-50A Durometer,  
RMS-348 Threaded Stem: Brass, RMS-349C

- Typical Compression for 5 kg Maximum Load = 0.8

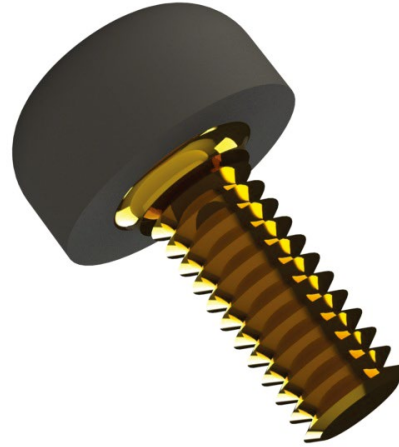
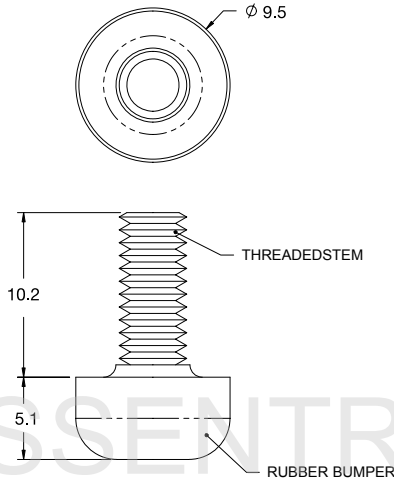

Part Number	Thread Type	Std Pack Qty
TB-1	#6-32	100
TB-2	#8-32	100
1342660	M3	100
1342662	M4	100
TB-5	M3	100

RFSI

## Rubber Foot Snap In

Black TPV, RMS-262

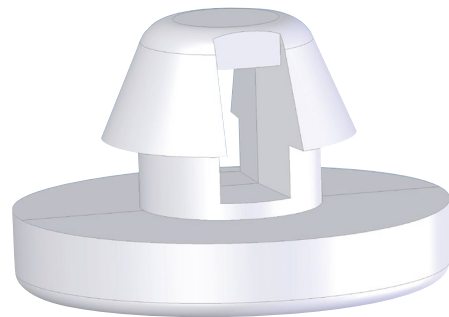
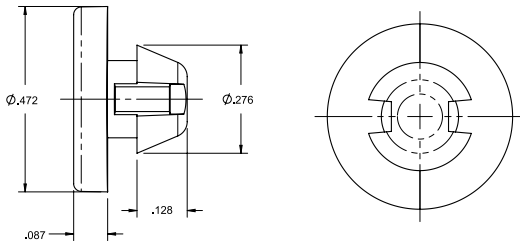

Part Number	Accepts Panel Hole(mm)	Accept Panel Thickness(mm)	Std Pack Qty
RFSI-1	5.6	1.6-1.7	1000

**BIB**

## Blind Install Bumper

Black Silicone Rubber, 45 Shore A, RMS-364

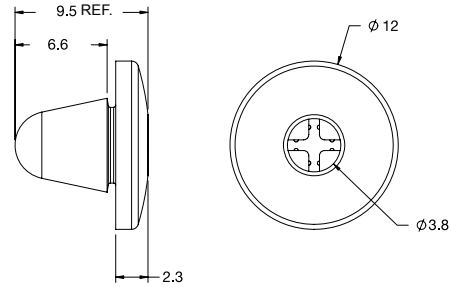

Part Number	Mounting Hole	Panel Thickness	Std Pack Qty
BIB-1	5 - 5.4	0.8-1.6	1000

**BAB**

## Break-Away Bumper

- Mounting tab designed to break-away after assembly to save space

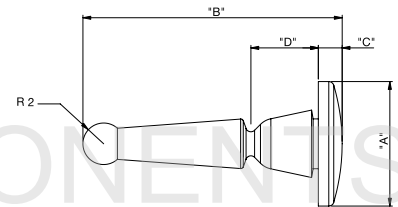
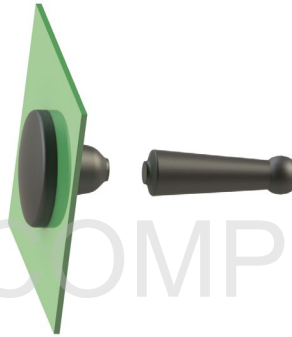

Part Number	Dimensions (mm)					Panel Thickness	Hole Ø	Material	Std Pack Qty
	"A"	"B"	"C"	"D"					
BAB-1	12	25	2.3	6.5	0.6 - 0.8	5 - 5.4	Black Silicone Rubber, 40 Shore A, RMS-316	1000	
BAB-2	12	25	2.3	6.5	0.6 - 0.8	5 - 5.4	Black Silicone Rubber, 40 Shore A, RMS-316	1000	
BAB-3	10	20	2	4.3	0.5	4.7 - 5	Black Silicone Rubber, 50 Shore A, RMS-364	1000	

**BPM**

## Pull Mount Bumper

Silicone Rubber, 65 Shore A, RMS-321

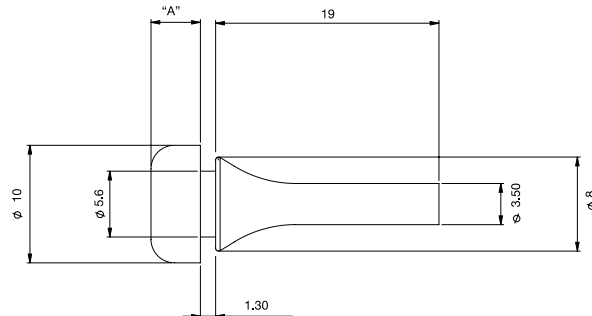

Part Number	Dimensions (mm)				Color	Std Pack Qty
	"A"	Hole Ø	Panel Thickness			
BPM-1-60	3	6 - 6.35	1.5	Grey	1000	
BPM-2	4.2	6 - 6.35	1.5	Black	1000	
BPM-3-60	5	6 - 6.35	1.5	Black	1000	

# Self-Adhesive, Screw-On Feet and Bumpers

SR 1593

## Stick-On Feet/Buffers

Polyurethane (PU)

- Ideal as feet or as furniture door buffers
- Easy to apply
- Self-adhesive backing
- Suitable for most smooth and dry surfaces

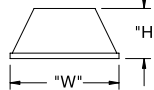
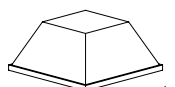

Type 1

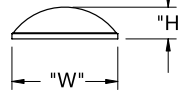

Type 2

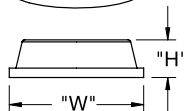

Type 3

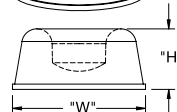

Type 4



Type 5

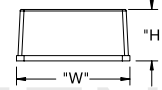
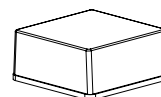

Type 6

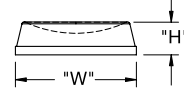

Type 7

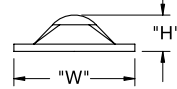
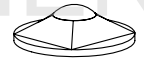

Type 8

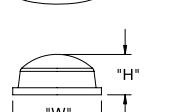

Type 9

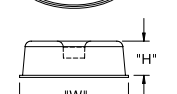

Type 10

### Black & Clear

Type	Part Number		Dimensions (mm)		Std Pack Qty
	Black	Clear	Height (H)	Base Diameter (W)	
1	RBS-20BK	RBS-20	2.5	10.2	5082
1	32426	-	3.1	12.7	3000
1	32427	462164	5.7	12.7	3000
1	RBS-3RBK	RBS-3R	5.8	12.7	5000
1	RBS-32RBK	RBS-32R	3.1	12.7	5000
1	RBS-29BK	RBS-29	6.4	19.8	2940
1	462171	462172	7.5	20.5	1000
1	RBS-19BK	RBS-19	7.6	20.5	2646
2	-	462155	1.9	6.4	10000
2	-	462156	2.2	8.0	10000
2	RBS-7BK	RBS-7	2.2	8.6	5400
2	461230	461232	3.1	10.0	3000
2	RBS-1BK	RBS-1	3.5	12.7	5000
2	RBS-44BK	RBS-44	4.1	19.1	2450
2	32430	32429	5.0	11.1	3000
2	32432	461234	9.5	19.0	1000
3	461236	461238	1.8	10.0	3000
3	RBS-5BK	RBS-5	1.6	12.7	5000
3	461241	462169	1.9	19.0	3000
3	RBS-72BK	RBS-72	2.5	31.5	2400
3	RBS-34BK	RBS-34	3.1	9.5	6000
3	RBS-24BK	RBS-24	3.1	20.5	4000
3	32433	461235	3.5	7.5	3000
3	32435	32434	3.5	12.7	3000
3	462159	462160	4.0	10.0	10000
3	39864	-	4.0	19.0	2600
3	-	462165	4.5	14.0	5000
3	RBS-35BK	RBS-35	4.8	9.5	5000
3	RBS-41BK	RBS-41	5.1	20.0	3360
3	462168	-	6.0	18.0	2000
3	43045	-	6.2	20.0	2000
3	RBS-6BK	RBS-6	6.3	12.7	5000
3	RBS-11BK	RBS-11	10.1	15.9	2560
4	462176	-	10.1	22.3	1000
5	RBS-17BK	RBS-17	10.1	22.3	1440
6	RBS-36BK	RBS-36	4.7	25.4	2310
6	RBS-4BK	RBS-4	9.7	19.8	5600
7	RBS-18BK	RBS-18	3.5	12.7	5000
8	-	RBS-33-SD	3.8	12.7	5000
9	RBS-40BK	RBS-40	1.6	6.4	15028
9	RBS-27BK	RBS-27	2.2	7.9	5400
9	-	RBS-10	3	10	7200
9	RBS-12BK	RBS-12	3.8	9.6	7200
9	RBS-22BK	RBS-22	5.4	9.6	6000
9	RBS-2BK	RBS-2	5.1	11.1	5082
9	RBS-15BK	RBS-15	7.9	16.0	3200
9	RBS-8BK	RBS-8	9.6	17.6	2254
9	RBS-37BK	RBS-37	14.2	18.3	1500
9	RBS-39BK	RBS-39	1.9	19.1	5040
10	RBS-30BK	RBS-30	15.8	45.7	500

### Grey & White

Type	Part Number		Dimensions (mm)		Std Pack Qty
	Grey	White	Height (H)	Base Diameter (W)	
1	461229	-	2.5	10.0	3000
1	462170	32428	7.5	20.5	1000
2	461231	-	3.1	10.0	3000
2	-	32431	8.0	16.0	1000
2	461233	-	9.5	19.0	1000
3	461237	-	1.8	10.0	3000
3	462173	-	3.0	19.7	4000
3	461240	461239	3.5	12.7	3000
4	32436	-	10.1	22.3	1000

SR 1503

## Stacking Buffers

Transparent PVC

- Suitable for glass shelf and table-top supports
- Concave head provides a light suction effect

Black PVC

- Push-fit range ideal for stacking chairs

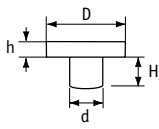
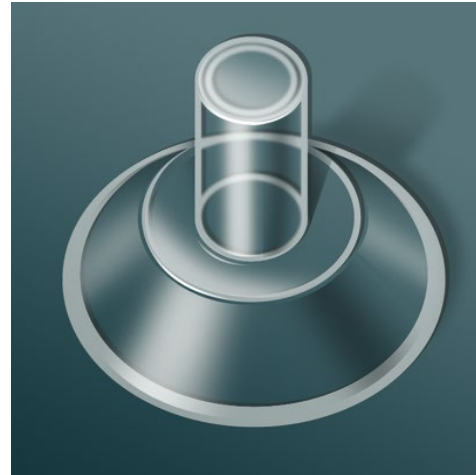

Type 1

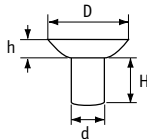

Type 2

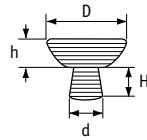

Type 3

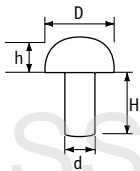

Type 1

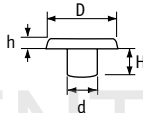

Type 2

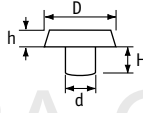

Type 3

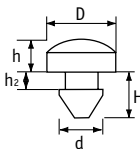

Type 4

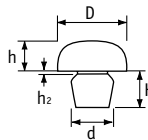

Type 5

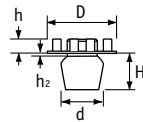

Type 6

Transparent PVC

Part Number	Type	Dimensions (mm)				Std Pack Qty
		D	d	h	H	
1251324	2	15	6	4.0	10.0	5000
1251326	3	20	6	10.0	4.0	5000
1251340	3	25	7	12.0	5.0	5000

Black PVC

Part Number	Type	Dimensions (mm)					Std Pack Qty
		D	d	h	h <sub>2</sub>	H	
1251328	1	9.0	5	3.0	-	6.0	5000
1251325	1	14.0	6	6.5	-	15.0	5000
1251338	1	20.0	10	8.0	-	10.0	2500
1251335	2	9.5	5	3.0	-	6.0	5000
1251334	2	12.0	6	3.0	-	7.5	5000
1251337	2	14.0	6	4.0	-	15.0	5000
1251336	2	18.0	8	5.0	-	15.0	5000
1251330	2	20.0	8	5.0	-	15.0	2500
1251327	2	24.0	11	5.0	-	13.0	2500
1251333	3	12.0	6	2.5	-	9.0	5000
1287140	4	12.0	5	4.0	4.5	8.0	5000
1251339	5	12.0	6	2.0	1.0	-	5000
1251329	5	12.0	6	4.5	1.0	-	5000

SR 1503

## Double Saddle Feet

Black Nylon

- Used to connect adjacent tubes

Part Number	Dimensions (mm)		Std Pack Qty
	Fits Tube Dia	Distance Between Tube Centres	
466731	22	42	100
466732	25	42	100



SR 1503

## Saddle Bases

Black LDPE

- Act as feet when fitted to bottom of tubes



Part Number	Type	Dimensions (mm)			Hole or Peg Dia (mm)	Std Pack Qty
		Fits Tube Dia	Length	Width		
SBFA2225-B	1	22-25	50	22	5.0	1000
SBFA25-45B	1	25	45	25	5.7	1000
SBFA2830-B	1	28-30	45	25	5.0	1000
466733	2	16-19	33	22	5.0	500
466734	2	22-25	35	25	5.0	500
466735	2	28-32	40	31	5.0	250



Type 1

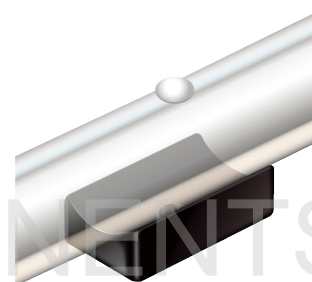

Type 2

SR 1503

## Metric Saddle Feet

Black LDPE

- Fit around metal tubes to act as a foot
- Ideal for protecting floor surfaces

Part Number	Dimensions (mm)		Std Pack Qty
	Fits Tube Dia	Peg Dia	
461151	14-16	5.5	4000
461152	16-18	5.5	4000
461153	18-20	5.5	4000
465457	20-22	5.5	3000
465456	24-26	7.5	1500
465452	28-30	7.5	1500

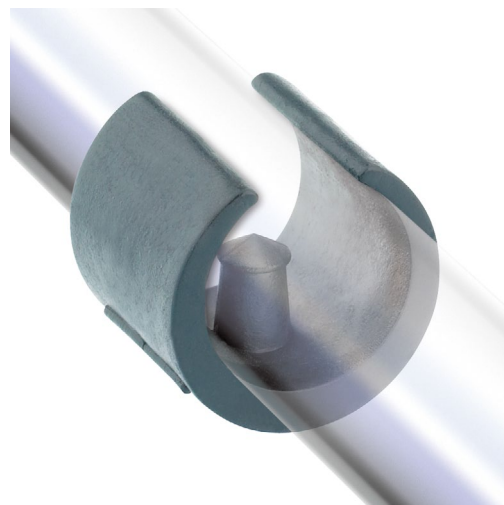

SR 1526

## Angled & Flat Bar Feet

Black PE or PVC

- Ferrules to suit right-angled and flat bars
- Can be used as feet
- Ridge on edge of angled base provides extra stability
- Protect floor surfaces

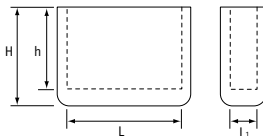
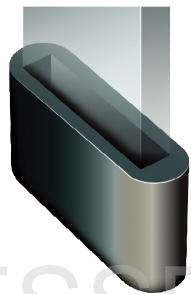
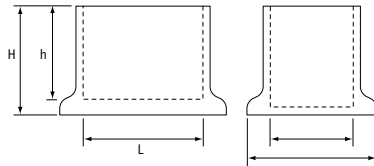

### Angle Bases - Black PE

Part Number	Dimensions (mm)			Std Pack Qty
	L	H	h	
465363	25 x 25	24	19	1000
HA300B	30 x 30	24	19	1000

### Bar Bases - Black PVC

Part Number	Dimensions (mm)			Std Pack Qty
	L x L <sub>1</sub>	H	h	
465361	25 x 5	19	15	2500
465364	25 x 6	19	15	1250
465362	30 x 6	19	15	2500

SR 1559

## Stand-Off Round Feet

Black LDPE



Part Number	Dimensions (mm)		Std Pack Qty
	D	L	
HIR200-20B	20	46.2	500
HIR320-15B *	30	51.5	500
HIR380-20B *	38	51.7	500

\* Plain shank

# Saddle and Insert Feet

SR 1559

## Stand-Off Square Feet

Black LDPE

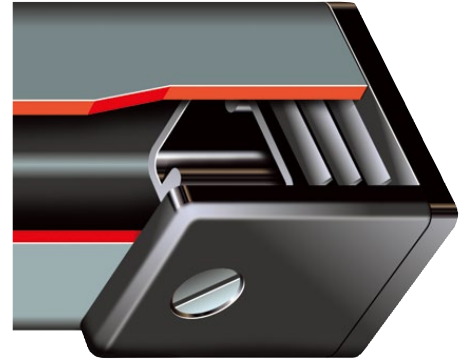
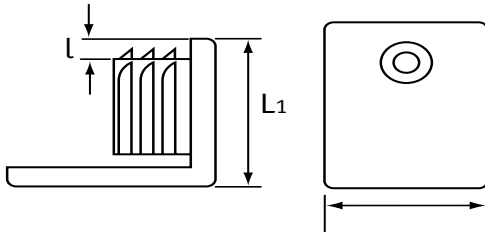

Part Number	Dimensions (mm)		Std Pack Qty
	L	I	
HIS200-RB	20	1.2	1000
HIS300-RBKNP	30	1.2	1000

SR 1559

## Stand-Off Rectangular Feet

Black LDPE

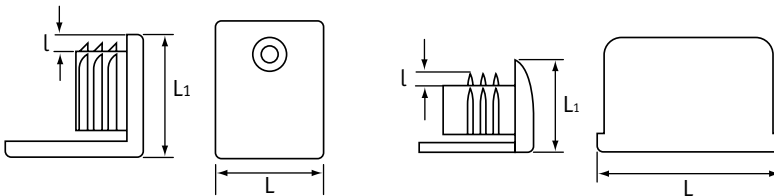

Type 1

Type 2



Part Number	Type	Dimensions (mm)		Std Pack Qty
		L x L <sub>1</sub>	I	
HIT300150-RB	1	30 x 15	1.2	1500
HIT400200-RB	1	40 x 20	1.2	1000
HIT500250-RB	1	50 x 25	1.2	500
HIT500300-RB	1	50 x 30	1.0-1.2	500
HITF400200-RB	2	40 x 20	1.2	500



SR 1547

## Twin Wheel Castor

Black Nylon

- Spark eroded finish
- Easy glide action
- Choice of mounting stems
- A choice of fittings below



Hooded



50mm - hooded Braked

### 30mm Hooded Twin Wheel Castors

Part Number	Wheel Dia. (mm)	Hooded	Braked	Max Static Load Bearing (kg)	Std Pack Qty
601448	30	Yes	No	30	100
601449	30	Yes	Yes	30	100

### 40mm Hooded Twin Wheel Castors

Part Number	Wheel Dia. (mm)	Hooded	Braked	Max Static Load Bearing (kg)	Std Pack Qty
601450	40	Yes	No	40	400
601451	40	Yes	Yes	40	400

### 30mm/40mm Hooded Twin Wheel Castors Fittings

Part Number	Type	Dimensions(mm)	Std Pack Qty
601452	2	M6*15 (L)	100
601453	2	M8*15 (L)	100
601456	3	30*30 (W) *1.5d=4	100
601457	3	38*38 (W) *1.5d=8	100
601454	1	8*18 (L)	100
601468	4		100
601469	4		100

ESSENTRA COMPONENTS



Type 1  
Gripneck Stem

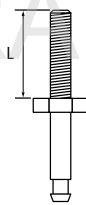

Type 2  
Threaded Stem

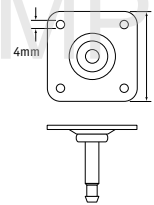

Type 3  
Plate Fixing

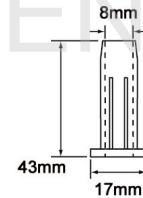

Type 4  
Plastic Socket for Gripneck Stem

### 50mm Hooded Twin Wheel Castors

Part Number	Wheel Dia. (mm)	Hooded	Braked	Max Static Load Bearing (kg)	Std Pack Qty
601458	50	Yes	No	50	300
601459	50	Yes	Yes	50	300

### 60mm Hooded Twin Wheel Castors

Part Number	Wheel Dia. (mm)	Hooded	Braked	Max Static Load Bearing (kg)	Std Pack Qty
601460	60	Yes	No	60	200
601461	60	Yes	Yes	60	200

### 50mm/60mm Hooded Twin Wheel Castors Fittings

Part Number	Type	Dimensions(mm)	Std Pack Qty
601462	2	M8*15 (L)	100
601463	2	M10*15 (L)	100
601465	3	35*35 (W) *1.5d=4	100
601466	3	38*38 (W) *2.0d=5	100
601467	3	42*42 (W) *2.0d=5	100
601464	1	8*38 (L)	100
601468	4		100
601469	4		100

The weight loadings quoted in this catalogue are for guide purposes only and assume that castors are used in a normal operating environment with floors in a smooth and reasonable condition.

Uneven or irregular floors will cause increased shock loadings. Castors of higher load-bearing capacity must be specified in these situations.

Castor loading capacity can be seriously impaired if castors are misused or poorly maintained, e.g. if used outside normal operating temperatures and/or if used in caustic environments.

## Raw Material Information

### UL® File Number & UL® Yellow Cards

Underwriter's Laboratories Inc. (UL®), plastics classification number is used to describe the performance of the material. Tests conducted by UL® may include the determination of material flammability (burning characteristics), ignition characteristics from various thermal and electrical sources, electrical tracking and other electrical characteristics, physical and mechanical characteristics, and analytical tests. In addition, the effect of long-term exposure to elevated temperature (air-oven aging), water, ultraviolet light, cold, etc. on property-retention may be evaluated.

**For more information and to download the UL® Yellow Card for an Essentra Components product, please visit [www.ul.com](http://www.ul.com) and click on "Certifications".**

### UL® Flame Rating

UL94 classifications V0, V1, V2, and HB describe the flame retardancy levels for a given resin. V0 rated resins typically have the highest flame resistance followed by V1, V2, and HB.

**For more information on UL® Flame Ratings and the Vertical Burn Test, please visit [www.ul.com](http://www.ul.com).**

### Material Operating Temperatures

The Material Temperature Ranges shown in the RMS Table are based on datasheets from the respective resin manufacturers and/or UL®RTI values. The values shown are for reference only to assist in material selection for your application. As each resin manufacturer uses different methods to evaluate the performance of their resins, the temperature ranges shown cannot necessarily be used to compare materials directly.

## Adhesive Tape Usage Guidelines

### Loads & Product Usage Guidelines

Long-term maximum product application loads generally should not exceed 0.25 psi. The surface area of contact is very critical for bond strength, so the amount of tape used should be maximized based on the application. In general, the tensile strength of the adhesive is higher than the peel or shear strength, so the product should be designed to be loaded in tension whenever possible.

### Nylon & Adhesive Shelf Life

If products are kept under the Ideal Storage Conditions above, shelf life is 1 year from date of shipment.

An asterisk(\*) indicates data was not available at time of publication. Please see our website or contact your local Essentra Components Representative for the necessary documentation.

#### RAW MATERIAL SPECIFICATION/DISCLAIMER OF WARRANTY:

These Raw Material Specifications shall not be construed as creating an express warranty of description. The specifications are approximate and intended to serve only as guides and not as the basis of any sale, agreement or contract of goods sold by Essentra Components. Essentra Components reserves the right to change the raw material on any of its goods contained in this catalog without notice to any buyer. Further, these Raw Material Specifications have been provided by the manufacturer and Essentra Components does not warrant their accuracy.

## Temperature Considerations

Ideal application temperature for most Essentra Components adhesives is 70° - 100°F (21° - 38°C). Lower application temperatures should be avoided as the adhesive will be too firm and may not 'wet out' sufficiently. Operating temperatures of Essentra Components adhesives are shown in the RMS table.

### Application Guide

**Surface Condition:** The bonding surfaces must be clean, uniform, dry and free of condensation. Do not use on fabric, coarse concrete, loose paint, or rough, loose surfaces.

**Surface Preparation:** For maximum performance, clean the mounting surfaces with a cleaning solvent such as a 50/50 mixture of isopropyl alcohol and water. Be sure to follow the solvent manufacturer's directions for use. Some surfaces may require a sealant or primer to achieve the desired bonding. Test the product on your actual application.

**Application pressure:** Remove the release liner being very careful not to touch the adhesive surface and then quickly and firmly rub the product into place. Firm pressure is needed to ensure full contact and to allow the adhesive to fully wet-out on the mating surfaces.

**Dwell Time:** The bond strength is affected by the substrate surface, application temperature and dwell time. At room temperature approximately half of the bond strength will be obtained within the first half hour with the majority of the strength achieved within 24 hours. Therefore, whenever possible wait 24 hours before applying load.

**Acrylic vs. rubber based adhesives:** In general, rubber based adhesives offer higher initial tack whereas acrylic based adhesives maintain higher mechanical strength over time. One should evaluate the performance of the product on the actual end use application. Contact your local Essentra Components representative for additional physical property and chemical resistance data.

## Common Material Abbreviations

ABS = Acrylonitrile-butadiene-styrene	PPE/PS = Polyphenylene ether/ polystyrene alloy
Acetal/POM = Polyacetal	PPE/SB = Polyphenylene ether/styrene- butadiene alloy
CPVC = Chlorinated polyvinyl chloride	PPS = Polyphenylene sulfide
EPDM = Ethylene-propylene-diene-monomer	PS = Polystyrene
HDPE = High density polyethylene	PSU = Polysulfone
HIPS = High impact polystyrene	PU = Polyurethane
LCP = Liquid Crystal Polymer	PVC = Polyvinyl chloride
LDPE = Low density polyethylene	PVDF = Polyvinylidene fluoride
Nitrile Rubber = Acrylonitrile rubber	SEBS = Styrene-ethylene butylene-styrene block copolymer
Nylon = Polyamide (PA)	SIR = Silicone molding compound
PBT = Polybutylene terephthalate	TPE = Thermoplastic elastomer
PC = Polycarbonate	TPR = Thermoplastic rubber
PE = Polyethylene	
PEI = Polyether imide	
PP = Polypropylene	

RMS No.	Material Description	UL File No.	UL Flame Rating	RoHS Compliance	Material Temperature Range			
					°C		°F	
01	Nylon 6/6	E70062	V-2	Y	-40	- 85	-40	- 185
02	ABS	E38989	HB	Y	-40	- 95	-40	- 203
03	PC	E45587	HB	Y	-40	- 115	-40	- 239
04	PVC - Rigid	E41877	V-0	Y	0	- 50	32	- 122
05	PPE+PS	E121562	V-0	Y	-40	- 110	-40	- 230
06	LDPE	NO U.L.	Not rated	Y	-40	- 65	-40	- 149
07	HDPE	E41877	V-0	N	0	- 50	32	- 122
08	PP	E169973	HB	Y	0	- 65	32	- 149
09	ABS	E44741	HB	Y	0	- 60	32	- 140
10	PP	E169973	HB	Y	0	- 65	32	- 149
11	CPVC	E106426	V-0	Y	0	- 50	32	- 122
12	CAP	E31879	HB	Y	-20	- 50	-4	- 122
13	HDPE	NO U.L.	Not rated	Y	-20	- 65	-4	- 149
14	Acetal - US	E38860	HB	Y	-50	- 100	-58	- 212
14A	Acetal - UK	E42337	HB	Y	-50	- 100	-58	- 212
15	Acrylic adhesive / PU foam tape / PE liner	MH16770	Not rated	Y	0	- 85	32	- 185
16A	HIPS - UK	E141073	HB	Y	-20	- 50	-4	- 122
16B	HIPS - US	E57787	HB	Y	-20	- 50	-4	- 122
17	Nylon 6/6	E41938	V-2	Y	-40	- 85	-40	- 185
18	Nylon 6/6, Heat Stabilized, 33% Glass Filled - US	E41938	HB	Y	-30	- 140	-22	- 284
18A	Nylon 6/6, F.R., 25% Glass Filled - UK	E41938	V-0	Y	-30	- 130	-22	- 266
19	Nylon 6/6, F.R.	E70062	V-0	Y	-40	- 110	-40	- 230
20	PVC - Rigid	E53006	V-0	Y	0	- 50	32	- 122
21	Nylon 66/6	E41938	HB	Y	-40	- 65	-40	- 149
23	PC, F.R.	E121562	V-0	Y	-40	- 130	-40	- 266
24	Rubber adhesive / PE foam tape / HDPE liner	NO U.L.	Not rated	Y	-20	- 60	-4	- 140
25	PVC - Flexible	NO U.L.	Not rated	Y	0	- 50	32	- 122
26	PVC - Flexible	E54709	V-0	Y	0	- 90	32	- 194
27	Nylon 6/6, F.R., 25% Glass Filled	E170540	V-0	Y	-30	- 65	-22	- 149
28	Polyester Felt Fiber	NO U.L.	Not rated	Y	-	-	-	-
29	304 Stainless Steel	NO U.L.	Not rated	Y	-200	- 870	-328	- 1598
30	CAP	NO U.L.	Not rated	Y	-	-	-	-
31	Aluminum	NO U.L.	Not rated	Y	-	-	-	-
32	PVC - Rigid	E41877	V-0	Y	0	- 50	32	- 122
33	Silicone Rubber and Fiberglass, F.R.	E59150	V-0	Y	-60	- 150	-76	- 302
34	Rubber adhesive / PE foam tape	NO U.L.	Not rated	Y	-40	- 71	-40	- 160
35	Nylon 6/6, 14% Glass Filled	E41938	HB	Y	-20	- 65	-4	- 149
38	Nylon 6, 30% Glass Filled	NO U.L.	Not rated	Y	-20	- 140	-4	- 284
39	Acetal	E41938	HB	Y	-40	- 95	-40	- 203
42	TPE	E80017	HB	Y	-60	- 95	-76	- 203
43	Nylon 6/6, F.R.	E53898	V-0	Y	-40	- 120	-40	- 248
45	Nylon 6/6, Heat Stabilized	E41938	HB	Y	-40	- 85	-40	- 185
46	Nylon 6/6, UV Stabilized	E70062	V-2	Y	-40	- 85	-40	- 185
47	Nylon 6/6, Heat Stabilized	E41938	V-2	Y	-40	- 125	-40	- 257
48	Nylon 6/6	E41871	V-2	Y	-40	- 90	-40	- 194
49	Nylon 6/6, F.R., 25% Glass Filled	E41871	V-0	Y	-40	- 130	-40	- 266
50	PPS, 40% Glass Filled	E54700	V-0	Y	-40	- 220	-40	- 428
51	PSU	E41871	V-2	Y	0	- 155	32	- 311
52	Nylon 6	E41871	V-2	Y	-40	- 115	-40	- 239
53	PBT	E121562	V-0	Y	-30	- 140	-22	- 284
54	PP	E169973	HB	Y	0	- 65	32	- 149
55	PVC - Flexible	E137220	V-0	Y	-35	- 50	-31	- 122
56	Nylon 4/6, Heat Stabilized	E172082	V-2	Y	-40	- 130	-40	- 266
58	Nylon 6	E148796	HB	Y	-20	- 65	-4	- 149
60	Nylon 6	E36632	V-2	Y	-40	- 65	-40	- 149
62	Nylon 6	E41871	V-2	Y	-40	- 115	-40	- 239
64	PU	E177325	HB	Y	0	- 50	32	- 122
65	Acrylic adhesive / PE coated paper liner	NO U.L.	Not rated	Y	-18	- 121	0	- 250

#### RAW MATERIAL SPECIFICATION/DISCLAIMER OF WARRANTY:

These Raw Material Specifications shall not be construed as creating an express warranty of description. The specifications are approximate and intended to serve only as guides and not as the basis of any sale, agreement or contract of goods sold by Essentra Components. Essentra Components Incorporated reserves the right to change the raw material on any of its goods contained in this catalog without notice to any buyer. Further, these Raw Material Specifications have been provided by the manufacturer and Essentra Components does not warrant their accuracy.

#### NYLON STORAGE GUIDELINES/SHELF LIFE:

All nylon parts are packaged in sealed plastic bags and contain an appropriate level of moisture. When stored in the original unopened bags at 73°F (23°C) and 50% RH, parts shelf life is one year from date of shipment.

# RMS Specifications

RMS No.	Material Description	UL File No.	UL Flame Rating	RoHS Compliance	Material Temperature Range					
					°C		°F			
66	Nylon 6/6, F.R.	E78964	V-0	Y	-40	-	65	-40	-	149
67	TPE	E80017	HB	Y	-60	-	95	-76	-	203
68	Rubber adhesive / PE coated paper liner	NO U.L.	Not rated	Y	-18	-	82	0	-	180
70	PVC, F.R.	E86418	V-0	Y	0	-	50	32	-	122
71	Nylon 6	E36632	V-2	Y	-40	-	85	-40	-	185
72	PC	E123529	V-2	Y	-40	-	80	-40	-	176
73	Nylon 6/6	E41938	HB	Y	-40	-	85	-40	-	185
74	Nylon 6/6	E41938	V-2	Y	-40	-	85	-40	-	185
75	Nylon 6/6, F.R.	E116324	V-0	Y	-40	-	85	-40	-	185
76	TPE	E80017	HB	Y	-50	-	95	-58	-	203
78	Nylon 6/6	E53898	HB	Y	-40	-	105	-40	-	221
79	PC	E50075	V-2	Y	-40	-	105	-40	-	221
80	TPR	E80017	HB	Y	-40	-	50	-40	-	122
81	Nylon 6/6	E41797	V-2	Y	-40	-	85	-40	-	185
83	PVC	NO U.L.	Not rated	Y	0	-	50	32	-	122
84	Nylon 6/6	E36632	V-2	Y	-40	-	85	-40	-	185
85	Nylon 6	NO U.L.	Not rated	Y	-40	-	100	-40	-	212
86	PP	NO U.L.	Not rated	Y	0	-	65	32	-	149
87	Nylon 6, F.R.	E41797	V-0	Y	-40	-	130	-40	-	266
88	Nylon 6	E36632	HB	Y	-40	-	120	-40	-	248
91	Nylon 6/6, F.R.	E88499	V-0	Y	-20	-	120	-4	-	248
92	Acrylic adhesive / Acrylic foam tape / Paper liner	MH17478	Not rated	Y	-40	-	93	-40	-	199
93	Acrylic adhesive / PE foam tape / PE paper liner	NO U.L.	Not rated	Y	-40	-	70	-40	-	158
94	PP	NO U.L.	Not rated	Y	0	-	65	32	-	149
95	Nylon 6, F.R., Heat Stabilized	E147510	V-0	Y	-40	-	65	-40	-	149
96	Hot Melt Adhesive	R6022	Not rated	Y	-	-	-	-	-	-
98	TPE	NO U.L.	Not rated	Y	-40	-	120	-40	-	248
99	Acrylic adhesive / PU foam tape / PE liner	NO U.L.	Not rated	Y	-40	-	100	-40	-	212
100	TPE	NO U.L.	Not rated	Y	-40	-	70	-40	-	158
102	Rubber adhesive / PE foam tape / PE film liner	MH15436	Not rated	Y	-18	-	66	0	-	150
103	Nylon 6/66, F.R.	E41871	V-0	Y	-40	-	120	-40	-	248
104	Nylon 6/6, F.R., Heat Stabilized, 25% Glass Filled	E41938	V-0	Y	-40	-	130	-40	-	266
105	PPE/PS	E148878	V-0	Y	-30	-	100	-22	-	212
106	Nylon 66	NO U.L.	Not rated	Y	-40	-	120	-40	-	248
107	PC	E146413	V-0	Y	-40	-	80	-40	-	176
109	Nylon 4/6, Heat Stabilized	E47960	V-2	Y	-40	-	130	-40	-	266
110	PBT, F.R., 30% Glass Filled	E130155	V-0	Y	-30	-	140	-22	-	284
111	PBT	E45575	V-0	Y	-30	-	130	-22	-	266
112	Nylon 6/6, F.R., 25% Glass Filled	E36632	V-0	Y	-40	-	130	-40	-	266
113	Acrylic adhesive / PE foam tape / PE liner	NO U.L.	Not rated	Y	-18	-	107	0	-	225
114	ABS	E56070	HB	Y	0	-	85	32	-	185
115	Nylon 6/6	E41938	V-2	Y	-30	-	85	-22	-	185
116	Nylon 6/6	NO U.L.	Not rated	Y	-20	-	85	-4	-	185
117	Polystyrene, F.R.	E140692	V-0	Y	-20	-	50	-4	-	122
118	PVC - Flexible	NO U.L.	Not rated	Y	0	-	50	32	-	122
119	Rubber adhesive / PE foam tape / PE liner	NO U.L.	Not rated	Y	18	-	65	65	-	149
120	Nylon 6	E53664	V-2	Y	-40	-	85	-40	-	185
121	Acetal	E41938	HB	Y	-50	-	95	-58	-	203
122	Nylon 6	E41938	V-2	Y	-40	-	85	-40	-	185
123	Silicone Rubber	E224733	HB	Y	-40	-	150	-40	-	302
124	PP	E41877	V-2	Y	0	-	105	32	-	221
126	PP	NO U.L.	Not rated	Y	0	-	65	32	-	149
127	Acetal	NO U.L.	Not rated	Y	-50	-	90	-58	-	194
128	Rubber adhesive/PE foam tape/Silicone coated paper liner	NO U.L.	Not rated	Y	18	-	65	65	-	149
129	Rubber adhesive/PE foam tape/Silicone coated paper liner	NO U.L.	Not rated	Y	18	-	65	65	-	149
130	PPE/PS	E45587	V-0	Y	-40	-	110	-40	-	230
131	Acrylic adhesive / Rubber foam tape	NO U.L.	Not rated	Y	-40	-	85	-40	-	185
132	Adhesive Transfer Tape	MH17478	Not rated	Y	-34	-	150	-30	-	302

An asterisk (\*) indicates data was not available at time of publication. Please see our website or contact your local Essentra Components Representative for the necessary documentation.

## RAW MATERIAL SPECIFICATION/DISCLAIMER OF WARRANTY:

These Raw Material Specifications shall not be construed as creating an express warranty of description. The specifications are approximate and intended to serve only as guides and not as the basis of any sale, agreement or contract of goods sold by Essentra Components. Essentra Components Incorporated reserves the right to change the raw material on any of its goods contained in this catalog without notice to any buyer. Further, these Raw Material Specifications have been provided by the manufacturer and Essentra Components does not warrant their accuracy.

## NYLON STORAGE GUIDELINES/SHELF LIFE:

All nylon parts are packaged in sealed plastic bags and contain an appropriate level of moisture. When stored in the original unopened bags at 73°F (23°C) and 50% RH, parts shelf life is one year from date of shipment.

RMS No.	Material Description	UL File No.	UL Flame Rating	RoHS Compliance	Material Temperature Range					
					°C		°F			
133	Nylon 6/6	E53898	HB	Y	-40	-	105	-40	-	221
134	LDPE	NO U.L.	Not rated	Y	0	-	65	32	-	149
135	Acrylic adhesive / Silicone foam	E57750	V-0	Y	-29	-	150	-20	-	302
136	Rubber adhesive / PE foam tape / PE liner	NO U.L.	Not rated	Y	-40	-	60	-40	-	140
138	Nylon 66/6, F.R., Heat Stabilized	E44716	V-0	Y	-50	-	95	-58	-	203
140	PBT	E245249	V-0	Y	-30	-	125	-22	-	257
141	PVDF	E54699	V-0	Y	-30	-	50	-22	-	122
142	LDPE/HDPE	NO U.L.	Not rated	Y	0	-	70	32	-	158
143	Acrylic adhesive / PE foam tape / PP liner	NO U.L.	Not rated	Y	-40	-	70	-40	-	158
144	PVC	NO U.L.	Not rated	Y	0	-	50	32	-	122
145	PPE/PS	E45329	V-0	Y	-30	-	65	-22	-	149
146	Nylon 6/10, F.R.	E41797	V-0	Y	-40	-	65	-40	-	149
147	Nylon 66	E141008	V-2	Y	-40	-	85	-40	-	185
148	Nylon 6/6	E70062	HB	Y	-40	-	65	-40	-	149
149	ASA/AES	E44741	HB	Y	-40	-	50	-40	-	122
150	PP	NO U.L.	Not rated	Y	0	-	65	32	-	149
150A	PP	E231371	HB	Y	0	-	65	32	-	149
151	PP, Conductive	E45195	HB	Y	0	-	65	32	-	149
152	Aluminum	NO U.L.	Not rated	Y	-200	-	400	-328	-	752
153	EPDM Rubber	NO U.L.	Not rated	Y	-40	-	110	-40	-	230
154	Nylon 6	E76261	V-2	Y	-30	-	85	-22	-	185
155	LDPE/HDPE Blend, UV Stabilized	NO U.L.	Not rated	Y	0	-	65	32	-	149
156	Nylon 6/6	E53664	V-0	Y	-40	-	120	-40	-	248
157	Nylon 6, Heat Stabilized	NO U.L.	Not rated	Y	-40	-	130	-40	-	266
158	TPE	E80017	HB	Y	-50	-	95	-58	-	203
159	Nylon 6	E47960	V-2	Y	-30	-	85	-22	-	185
160	Acetal	E45034	HB	Y	-50	-	100	-58	-	212
161	PC	E41179	V-2	Y	-40	-	125	-40	-	257
162	PEI	E247337	V-0	Y	-40	-	200	-40	-	392
163	HIPS	E108538	HB	Y	-20	-	50	-4	-	122
164	Nylon 6/6, Heat Stabilized	E70062	V-2	Y	-40	-	125	-40	-	257
165	Nylon 6/6, UV Stabilized	E70062	V-2	Y	-40	-	85	-40	-	185
166	EPDM Rubber	NO U.L.	Not rated	Y	-40	-	50	-40	-	122
167	TPE	E80017	HB	Y	-40	-	50	-40	-	122
168	TPE	E80017	HB	Y	-40	-	50	-40	-	122
169	Nylon 6/6, F.R.	E53898	V-0	Y	-40	-	120	-40	-	248
170	Ceramic	NO U.L.	Not rated	Y	-40	-	1700	-40	-	3092
171	ABS	E56070	HB	Y	0	-	60	32	-	140
172	Nylon 6/6, Heat Stabilized	E41938	HB	Y	-40	-	110	-40	-	230
173	Nylon 6, 25% Glass Filled	NO U.L.	Not rated	Y	-20	-	140	-4	-	284
174	Nylon 6/6	E86615	V-2	Y	0	-	65	32	-	149
175	Mild Steel	NO U.L.	Not rated	Y	-	-	-	-	-	-
176	PVC/TPE	NO U.L.	Not rated	Y	-30	-	100	-22	-	212
177	PP	E54080	V-2	Y	0	-	65	32	-	149
179	Nylon 6/6	E86615	V-2	Y	-20	-	65	-4	-	149
180	EPDM Rubber	NO U.L.	Not rated	Y	-20	-	90	-4	-	194
181	PC	E121254	V-0	Y	-40	-	80	-40	-	176
182	TPE	E80017	HB	Y	-30	-	95	-22	-	203
183	HDPE	NO U.L.	Not rated	Y	0	-	65	32	-	149
184	LCP	E83005	V-0	Y	0	-	130	32	-	266
185	TPE	NO U.L.	Not rated	Y	-50	-	130	-58	-	266
186	PVC	NO U.L.	Not rated	Y	-10	-	50	14	-	122
187	PVC, UV Stabilized - Rigid	NO U.L.	Not rated	Y	-20	-	70	-4	-	158
188	PVC - Rigid	NO U.L.	Not rated	Y	-20	-	60	-4	-	140
189	Nylon 66, 15% Glass Filled	NO U.L.	Not rated	Y	-20	-	85	-4	-	185
190	Neoprene Rubber	NO U.L.	Not rated	Y	-40	-	50	-40	-	122
191	PVC - Rigid	NO U.L.	Not rated	Y	0	-	50	32	-	122
192	Nylon 11 Coating	NO U.L.	Not rated	Y	-40	-	140	-40	-	284

An asterisk (\*) indicates data was not available at time of publication. Please see our website or contact your local Essentra Components Representative for the necessary documentation.

#### RAW MATERIAL SPECIFICATION/DISCLAIMER OF WARRANTY:

These Raw Material Specifications shall not be construed as creating an express warranty of description. The specifications are approximate and intended to serve only as guides and not as the basis of any sale, agreement or contract of goods sold by Essentra Components. Essentra Components Incorporated reserves the right to change the raw material on any of its goods contained in this catalog without notice to any buyer. Further, these Raw Material Specifications have been provided by the manufacturer and Essentra Components does not warrant their accuracy.

#### NYLON STORAGE GUIDELINES/SHELF LIFE:

All nylon parts are packaged in sealed plastic bags and contain an appropriate level of moisture. When stored in the original unopened bags at 73°F (23°C) and 50% RH, parts shelf life is one year from date of shipment.

# RMS Specifications

RMS No.	Material Description	UL File No.	UL Flame Rating	RoHS Compliance	Material Temperature Range					
					°C		°F			
193	PVC - Rigid	NO U.L.	Not rated	Y	0	-	50	32	-	122
194	Aluminum	NO U.L.	Not rated	Exempt	-	-	-	-	-	-
195	PVC - Rigid	NO U.L.	Not rated	Y	0	-	50	32	-	122
196	PVC Coating	NO U.L.	Not rated	Y	0	-	50	32	-	122
197	30301 Stainless Steel	NO U.L.	Not rated	Y	-129	-	287.8	-200	-	550
198	Cold Rolled Steel	NO U.L.	Not rated	Y	-	-	-	-	-	-
199	Aluminum	NO U.L.	Not rated	Y	-	-	-	-	-	-
200	TPE	NO U.L.	Not rated	Y	0	-	50	32	-	122
201	Nitrile Rubber	NO U.L.	Not rated	Y	-40	-	80	-40	-	176
202	Acetal	E38860	HB	Y	-50	-	100	-58	-	212
203	Soft Steel	NO U.L.	Not rated	Exempt	-	-	-	-	-	-
204	PC	E121562	HB	Y	-40	-	130	-40	-	266
205	Nylon 6/6, 25% Glass Filled	E116324	V-0	Y	-40	-	95	-40	-	203
206	Spring Steel	NO U.L.	Not rated	Y	-	-	-	-	-	-
207	Natural Rubber	NO U.L.	Not rated	Y	0	-	50	32	-	122
208	PVC	NO U.L.	Not rated	Y	0	-	50	32	-	122
209	Silicone Oil	NO U.L.	Not rated	Y	-	-	-	-	-	-
210	Silicone Rubber	NO U.L.	Not rated	Y	-40	-	150	-40	-	302
211	Nylon 66, Heat Stabilized	NO U.L.	Not rated	Y	-40	-	65	-40	-	149
212	Carbon Steel	NO U.L.	Not rated	Y	-	-	-	-	-	-
213	TPE	NO U.L.	Not rated	Y	-50	-	90	-58	-	194
214	TPE	NO U.L.	Not rated	Y	-50	-	90	-58	-	194
215	PC	E157291	V-2	Y	-40	-	120	-40	-	248
216	Black Oxide & Oil Coating	NO U.L.	Not rated	Y	-	-	-	-	-	-
217	Nickel Tin Plating	NO U.L.	Not rated	Y	-	-	-	-	-	-
218	PC	E121562	HB	Y	-40	-	100	-40	-	212
219	Zinc Plating	NO U.L.	Not rated	Y	-	-	-	-	-	-
220	Nylon 6/6	E41938	V-2	Y	-40	-	85	-40	-	185
221	Nylon 6/6, UV Stabilizer	E41938	V-2	Y	-40	-	85	-40	-	185
222	Nylon 6/6, 30% Glass Filled	E84658	V-0	Y	-30	-	140	-22	-	284
223	ABS, F.R.	E162823	V-0	Y	0	-	60	32	-	140
224	Stainless Steel - Passivated	NO U.L.	Not rated	Y	-	-	-	-	-	-
225	Polyolefin	NO U.L.	Not rated	Y	0	-	65	32	-	149
226	Modified PE Adhesive	NO U.L.	Not rated	Y	-	-	-	-	-	-
227	Stainless Spring Steel	NO U.L.	Not rated	Exempt	-129	-	287.8	-200	-	550
228	Stainless Steel	NO U.L.	Not rated	Y	-	-	-	-	-	-
229	Nickel Chrome Plating	NO U.L.	Not rated	Y	-	-	-	-	-	-
230	Stainless Spring Steel	NO U.L.	Not rated	Y	-129	-	287.8	-200	-	550
231	Brass	NO U.L.	Not rated	Exempt	-	-	-	-	-	-
232	Mild Steel	NO U.L.	Not rated	Exempt	-	-	-	-	-	-
233	409 Stainless Steel	NO U.L.	Not rated	Y	-	-	-	-	-	-
234	Nickel Plating	NO U.L.	Not rated	Y	-	-	-	-	-	-
235	Zinc Bichromate Plating	NO U.L.	Not rated	Y	-	-	-	-	-	-
236	Zinc Plating	NO U.L.	Not rated	Y	-	-	-	-	-	-
237	Mild Steel	NO U.L.	Not rated	Y	-	-	-	-	-	-
238	Spring Steel	NO U.L.	Not rated	Y	-	-	-	-	-	-
239	Painted Marking	NO U.L.	Not rated	Y	-	-	-	-	-	-
240	Rubber & Nylon - Fiber	NO U.L.	Not rated	Y	0	-	38	-18	-	100
241	Neoprene Rubber	NO U.L.	Not rated	Y	-40	-	80	-40	-	176
242	Carbon Steel	NO U.L.	Not rated	Y	-	-	-	-	-	-
243	Soft Electrogalvanized Steel	NO U.L.	Not rated	Y	-	-	-	-	-	-
244	Nylon 66	E41938	V-2	Y	-40	-	85	-40	-	185
245	Copper Flat Wire	NO U.L.	Not rated	Exempt	-	-	-	-	-	-
246	Tin Plating	NO U.L.	Not rated	Y	-	-	-	-	-	-
247	Aluminum	NO U.L.	Not rated	Y	-200	-	400	-328	-	752
248	Nylon 66, F.R.	E41938	V-0	Y	-40	-	85	-40	-	185
249	PE Hook	NO U.L.	Not rated	Y	0	-	60	32	-	140
250	Nylon Buckle	NO U.L.	Not rated	Y	-40	-	65	-40	-	149

An asterisk (\*) indicates data was not available at time of publication. Please see our website or contact your local Essentra Components Representative for the necessary documentation.

## RAW MATERIAL SPECIFICATION/DISCLAIMER OF WARRANTY:

These Raw Material Specifications shall not be construed as creating an express warranty of description. The specifications are approximate and intended to serve only as guides and not as the basis of any sale, agreement or contract of goods sold by Essentra Components. Essentra Components Incorporated reserves the right to change the raw material on any of its goods contained in this catalog without notice to any buyer. Further, these Raw Material Specifications have been provided by the manufacturer and Essentra Components does not warrant their accuracy.

## NYLON STORAGE GUIDELINES/SHELF LIFE:

All nylon parts are packaged in sealed plastic bags and contain an appropriate level of moisture. When stored in the original unopened bags at 73°F (23°C) and 50% RH, parts shelf life is one year from date of shipment.

RMS No.	Material Description	UL File No.	UL Flame Rating	RoHS Compliance	Material Temperature Range			
					°C		°F	
251	Nylon Loop	NO U.L.	Not rated	Y	-40	- 65	-40	- 149
252	Ferrite Terminal	NO U.L.	Not rated	Exempt	-	-	-	-
253	Nylon 66, Glass Filled	NO U.L.	Not rated	Y	-40	- 65	-40	- 149
254	Stainless Steel	NO U.L.	Not rated	Exempt	-129	- 287.8	-200	- 550
255	PP/Polyester Blend	NO U.L.	Not rated	Y	-	-	-	-
256	ABS/PC	E168806	V-0	Y	0	- 60	32	- 140
257	Phosphor Bronze	NO U.L.	Not rated	Y	-	-	-	-
258	Chrome Plating	NO U.L.	Not rated	Y	-	-	-	-
259	Spring Steel	NO U.L.	Not rated	Y	-	-	-	-
260	Brass	NO U.L.	Not rated	Exempt	-	-	-	-
261	Electroplated Steel	NO U.L.	Not rated	Y	-	-	-	-
262	TPE	E80017	HB	Y	-50	- 95	-58	- 203
263	TPE, F.R.	E80017	V-0	Y	-40	- 90	-40	- 194
264	PE Foam Coating	NO U.L.	Not rated	Y	0	- 65	32	- 149
265	PVC - Flexible	NO U.L.	Not rated	Y	0	- 50	32	- 122
266	Galvanized Steel	NO U.L.	Not rated	Y	-	-	-	-
267	Acetal	E120354	HB	Y	-50	- 100	-58	- 212
268	PP	NO U.L.	Not rated	Y	0	- 65	32	- 149
269	PVC	NO U.L.	Not rated	Y	0	- 50	32	- 122
271	PP	NO U.L.	Not rated	Y	0	- 65	32	- 149
272	Chrome Plating	NO U.L.	Not rated	Y	-	-	-	-
273	PC	E41179	V-2	Y	-40	- 125	-40	- 257
274	Yellow Chromate Zinc Plating	NO U.L.	Not rated	Y	-	-	-	-
275	Polyolefin Writing Surface	NO U.L.	Not rated	Y	0	- 60	32	- 140
276	Brass	NO U.L.	Not rated	Exempt	-	-	-	-
277	ABS	NO U.L.	Not rated	Y	0	- 60	32	- 140
278	Spring Steel	NO U.L.	Not rated	Y	-	-	-	-
279	Neoprene Rubber	NO U.L.	Not rated	Y	-40	- 80	-40	- 176
280	321 Stainless Steel	NO U.L.	Not rated	Exempt	-	-	-	-
281	Masterbatch	NO U.L.	Not rated	Y	-	-	-	-
282	Stainless Steel	NO U.L.	Not rated	Y	-	-	-	-
283	304 Stainless Steel	NO U.L.	Not rated	Y	-	-	-	-
284	HDPE	NO U.L.	Not rated	Y	0	- 60	32	- 140
285	LDPE	NO U.L.	Not rated	Y	0	- 50	32	- 122
286	TPE	NO U.L.	Not rated	Y	-50	- 90	-58	- 194
287	Nylon 6/6	NO U.L.	Not rated	Y	-40	- 65	-40	- 149
289	Brass	NO U.L.	Not rated	Y	-	-	-	-
290	PBT, 6% Glass Filled	NO U.L.	Not rated	Y	-30	- 120	-22	- 248
291	PTFE	NO U.L.	Not rated	Y	-70	- 400	-94	- 752
292	Silicone	NO U.L.	Not rated	Y	-40	- 150	-40	- 302
293	Pressure Sensitive Acrylic Adhesive	NO U.L.	Not rated	Y	-29	- 93	-20	- 199
294	Stainless Steel	NO U.L.	Not rated	Y	-	-	-	-
295	PP	NO U.L.	Not rated	Y	0	- 65	32	- 149
296	Silicone Compound	NO U.L.	Not rated	Y	-	-	-	-
297	Kevlar	NO U.L.	Not rated	Y	-100	- 400	-148	- 752
298	PVC - Flexible	NO U.L.	Not rated	Y	0	- 50	32	- 122
299	Nickel Plating	NO U.L.	Not rated	Y	-	-	-	-
300	Polyester Elastomer	NO U.L.	Not rated	Y	-40	- 140	-40	- 284
301	Epoxy Glue	NO U.L.	Not rated	Y	-	-	-	-
302	Ferrite Core	NO U.L.	Not rated	Exempt	-	-	-	-
303	Ferrite Core	NO U.L.	Not rated	Y	-	-	-	-
304	Ferrite Core	NO U.L.	Not rated	Exempt	-	-	-	-
305	Stainless Steel	NO U.L.	Not rated	Exempt	-	-	-	-
306	Tin Coated Copper Wire	NO U.L.	Not rated	Y	-	-	-	-
307	Tin Coated Copper Wire	NO U.L.	Not rated	Y	-	-	-	-
308	Tin Coated Copper Wire	NO U.L.	Not rated	Y	-	-	-	-
309	Steel Piano Wire	NO U.L.	Not rated	Exempt	-	-	-	-
310	Pressure Sensitive Acrylic Adhesive	NO U.L.	Not rated	Y	-29	- 93	-20	- 199

An asterisk (\*) indicates data was not available at time of publication. Please see our website or contact your local Essentra Components Representative for the necessary documentation.

**RAW MATERIAL SPECIFICATION/DISCLAIMER OF WARRANTY:**

These Raw Material Specifications shall not be construed as creating an express warranty of description. The specifications are approximate and intended to serve only as guides and not as the basis of any sale, agreement or contract of goods sold by Essentra Components. Essentra Components Incorporated reserves the right to change the raw material on any of its goods contained in this catalog without notice to any buyer. Further, these Raw Material Specifications have been provided by the manufacturer and Essentra Components does not warrant their accuracy.

**NYLON STORAGE GUIDELINES/SHELF LIFE:**

All nylon parts are packaged in sealed plastic bags and contain an appropriate level of moisture. When stored in the original unopened bags at 73°F (23°C) and 50% RH, parts shelf life is one year from date of shipment.

# RMS Specifications

RMS No.	Material Description	UL File No.	UL Flame Rating	RoHS Compliance	Material Temperature Range			
					°C		°F	
311	Polyethylene Hook	NO U.L.	Not rated	Y	0	- 50	32	- 122
312	Nylon Loop	NO U.L.	Not rated	Y	0	- 50	32	- 122
313	Pressure Sensitive Adhesive	NO U.L.	Not rated	Y	0	- 50	32	- 122
314	Acrylic adhesive / PE film / Silicone paper liner	NO U.L.	Not rated	Y	-80	- 100	-112	- 212
315	Nylon 6/6	E41938	V-2	Y	-40	- 85	-40	- 185
316	Silicone Rubber	NO U.L.	Not rated	Y	-40	- 150	-40	- 302
317	PVC - Flexible	NO U.L.	Not rated	Y	0	- 50	32	- 122
318	Epoxy Cover	NO U.L.	Not rated	Y	-	-	-	-
320	302 Stainless Steel	NO U.L.	Not rated	Y	-200	- 870	-328	- 1598
321	Silicone Rubber	NO U.L.	Not rated	Y	-40	- 150	-40	- 302
322	Silicone Rubber	E111943	HB	Y	-40	- 150	-40	- 302
323	Plastic Washer	NO U.L.	Not rated	Y	-	-	-	-
324	Rubber adhesive / PE foam tape / HDPE liner	NO U.L.	Not rated	Y	-40	- 100	-40	- 212
325	Fiberglass	NO U.L.	Not rated	Y	-	-	-	-
326	Spring Steel	NO U.L.	Not rated	Y	-	-	-	-
327	Spring Steel	NO U.L.	Not rated	Y	-	-	-	-
328	Stainless Steel	NO U.L.	Not rated	Y	-	-	-	-
329	Ferrite - Ceramic	NO U.L.	Not rated	Exempt	-	-	-	-
330	Ferrite - Paper Packaging Carrier Tape	NO U.L.	Not rated	Y	-	-	-	-
331	Wire - 2UEW	NO U.L.	Not rated	Y	-	-	-	-
332	Ceramic Body	NO U.L.	Not rated	Exempt	-	-	-	-
333	Copper Wire	NO U.L.	Not rated	Exempt	-	-	-	-
334	Ferrite K-15	NO U.L.	Not rated	Exempt	-	-	-	-
335	EVOH	NO U.L.	Not rated	Y	-	-	-	-
336	Stainless Steel	NO U.L.	Not rated	Y	-	-	-	-
337	Zinc Plating	NO U.L.	Not rated	Y	-	-	-	-
338	Steel	NO U.L.	Not rated	Y	-	-	-	-
339	Zinc Plating	NO U.L.	Not rated	Y	-	-	-	-
340	Steel	NO U.L.	Not rated	Exempt	-	-	-	-
341	Zinc Plating	NO U.L.	Not rated	Y	-	-	-	-
342	Polyester/PP Hook	NO U.L.	Not rated	Y	0	- 50	32	- 122
343	Hook and Loop	NO U.L.	Not rated	Y	0	- 50	32	- 122
344	Acrylic Adhesive	NO U.L.	Not rated	Y	0	- 50	32	- 122
345	Ferrite - Polystyrene Carrier Tape	NO U.L.	Not rated	*	-	-	-	-
346	Color Code Stripe Printing Ink	NO U.L.	Not rated	Y	-	-	-	-
347	Ferrite - Polyethylene Carrier Tape	NO U.L.	Not rated	*	-	-	-	-
348	Rubber IIR Bromobutyl	NO U.L.	Not rated	Y	-40	- 140	-40	- 284
349	Brass	NO U.L.	Not rated	Y	-	-	-	-
350	Double Coated Polyurethane Foam Tape	NO U.L.	Not rated	Y	-29	- 104	-20	- 219
351	TPE	NO U.L.	Not rated	Y	-40	- 100	-40	- 212
352	Carbon Steel	NO U.L.	Not rated	Y	-	-	-	-
353	Stainless Steel	NO U.L.	Not rated	Y	-	-	-	-
354	Zinc with Clear Dichromate Plating	NO U.L.	Not rated	Y	-	-	-	-
355	Chrome Plating	NO U.L.	Not rated	Y	-	-	-	-
356	Black Phosphate Coating	NO U.L.	Not rated	Y	-	-	-	-
357	Steel	NO U.L.	Not rated	Y	-	-	-	-
358	Zinc Plating	NO U.L.	Not rated	Y	-	-	-	-
359	Acrylic adhesive / PE foam tape / PE paper liner	NO U.L.	Not rated	Y	-40	- 95	-40	- 203
360	Butyl Rubber	NO U.L.	Not rated	Y	-40	- 140	-40	- 284
361	Acrylic adhesive / Acrylic foam / PE film liner	MH17478	Not rated	Y	-35	- 90	-31	- 194
362	PVC	NO U.L.	Not rated	Y	0	- 50	32	- 122
363	Nylon Buckle	NO U.L.	Not rated	Y	-40	- 85	-40	- 185
364	Silicone Rubber	NO U.L.	Not rated	Y	-40	- 150	-40	- 302
365	304 Stainless Steel	NO U.L.	Not rated	Y	-200	- 870	-328	- 1598
366	PE Hook	NO U.L.	Not rated	Y	0	- 50	32	- 122
367	Acrylic adhesive / PE copolymer foam / PE film liner	NO U.L.	Not rated	Y	-40	- 125	-40	- 257
368	Silicone Rubber	NO U.L.	Not rated	Y	-40	- 150	-40	- 302
369	18-8 Stainless Steel	NO U.L.	Not rated	Y	-	-	-	-

An asterisk (\*) indicates data was not available at time of publication. Please see our website or contact your local Essentra Components Representative for the necessary documentation.

## RAW MATERIAL SPECIFICATION/DISCLAIMER OF WARRANTY:

These Raw Material Specifications shall not be construed as creating an express warranty of description. The specifications are approximate and intended to serve only as guides and not as the basis of any sale, agreement or contract of goods sold by Essentra Components. Essentra Components Incorporated reserves the right to change the raw material on any of its goods contained in this catalog without notice to any buyer. Further, these Raw Material Specifications have been provided by the manufacturer and Essentra Components does not warrant their accuracy.

## NYLON STORAGE GUIDELINES/SHELF LIFE:

All nylon parts are packaged in sealed plastic bags and contain an appropriate level of moisture. When stored in the original unopened bags at 73°F (23°C) and 50% RH, parts shelf life is one year from date of shipment.



RMS No.	Material Description	UL File No.	UL Flame Rating	RoHS Compliance	Material Temperature Range					
					°C		°F			
370	304 Stainless Steel	NO U.L.	Not rated	Y	-200	-	870	-328	-	1598
371	Nylon 6, F.R., 30% Glass Filled	E140692	V-0	Y	-40	-	65	-40	-	149
372	Black Oxide Finish	NO U.L.	Not rated	Y	-	-	-	-	-	-
373	Brass	NO U.L.	Not rated	Y	-	-	-	-	-	-
374	TPE	E80017	HB	Y	-60	-	95	-76	-	203
375	Rubber adhesive / PE foam / Silicone paper liner	NO U.L.	Not rated	Y	0	-	70	32	-	158
376	Acrylic adhesive / Acrylic foam / PE liner	MH17478	Not rated	Y	-35	-	90	-31	-	194
377	Blue Polyolefin Pin	NO U.L.	Not rated	Y	0	-	50	32	-	122
378	Silicone Rubber	NO U.L.	Not rated	*	-40	-	150	-40	-	302
379	Silicone Rubber	NO U.L.	Not rated	Y	-40	-	150	-40	-	302
380	Nylon Tie	NO U.L.	Not rated	Y	-40	-	85	-40	-	185
381	304 Stainless Steel	NO U.L.	Not rated	Y	-200	-	870	-328	-	1598
382	316 Stainless Steel	NO U.L.	Not rated	Y	-200	-	870	-328	-	1598
383	Silicone Rubber	NO U.L.	Not rated	Y	-40	-	150	-40	-	302
384	TPE	E80017	HB	Y	-50	-	95	-58	-	203
385	Nylon 6/6	E41938	V-2	Y	0	-	85	32	-	185
386	Polyether Sulfone	E108538	V-0	Y	-30	-	190	-22	-	374
387	TPE	NO U.L.	Not rated	Y	-40	-	150	-40	-	302
388	PVC	NO U.L.	Not rated	Y	0	-	50	32	-	122
389	TPE	NO U.L.	Not rated	Y	0	-	60	32	-	140
390	Nylon 6, F.R.	NO U.L.	Not rated	Y	-40	-	85	-40	-	185
391	Acrylic adhesive / PP film / Silicone paper liner	NO U.L.	Not rated	Y	-	-	-	-	-	-
392	Nylon 6, Conductive	NO U.L.	Not rated	Y	0	-	60	-32	-	140
393	PBT	E36632	HB	Y	-30	-	140	-22	-	284
395	TPE	E80017	V-1	Y	-60	-	90	-76	-	194
396	Aluminum	NO U.L.	Not rated	Y	-40	-	115	-40	-	239
397	PP	NO U.L.	Not rated	*	0	-	65	32	-	149
398	Silicone Rubber	E207571	V-0	*	-40	-	150	-40	-	302
399	Nylon 6.6, UV Resistant	NO U.L.	V-2	*	-40	-	65	-40	-	149
400	Acrylic adhesive / PE foam / PE film liner	NO U.L.	Not rated	*	-	-	-	-	-	-
401	PP	NO U.L.	Not rated	Y	-	-	-	-	-	-
402	Polychloroprene Rubber	NO U.L.	Not rated	Y	-	-	-	-	-	-
403	Brass	NO U.L.	Not rated	Y	-	-	-	-	-	-
404	TPE	E80017	HB	Y	-60	-	85	-76	-	185
405	304 Stainless Steel	NO U.L.	Not rated	Y	-200	-	870	-328	-	1598
406	Nylon 6/6	E48285	V-2	Y	-40	-	85	-40	-	185
407	Liquid Silicone	NO U.L.	Not rated	Y	-40	-	150	-40	-	302
408	Magnetic Rubber	NO U.L.	Not rated	Y	-	-	-	-	-	-
409	LDPE	NO U.L.	Not rated	Y	-	-	-	-	-	-
410	Acrylic adhesive / PE foam tape / PE film liner	NO U.L.	Not rated	Y	-40	-	100	-40	-	212
411	PPE+PS, F.R.	E45329	V-0	Y	-30	-	65	-22	-	149
412	LDPE	NO U.L.	Not rated	Y	-	-	-	-	-	-
413	Nylon 6	NO U.L.	Not rated	Y	-	-	-	-	-	-
414	Acrylic Adhesive / Silicone Liner	MH13557	Not rated	Y	-29	-	150	-20	-	302
415	Mild Steel, Zinc Plated	NO U.L.	Not rated	Y	-	-	-	-	-	-
416	TPE	E80017	HB	Y	-60	-	85	-76	-	185
417	Silicone Rubber	NO U.L.	Not rated	Y	-40	-	150	-40	-	302
418	LDPE	NO U.L.	Not rated	Y	0	-	65	32	-	149
420	EPDM	NO U.L.	Not rated	Y	-20	-	-90	-4	-	194
421	LDPE	NO U.L.	Not rated	Y	0	-	65	32	-	149
422	PP, Modified	E111275	HB	Y	0	-	65	32	-	149
423	Nylon 6, Heat Stabilized	E47960	HB	Y	-40	-	65	-40	-	149
424	Nylon 6	E53898	V-0	Y	-40	-	120	-40	-	248
425	Silicone Rubber	E55519	HB	Y	-40	-	150	-40	-	302
426	Silicone Rubber	E55519	HB	Y	-40	-	150	-40	-	302
427	EPDM Rubber	NO U.L.	Not rated	Y	-20	-	90	-4	-	194
428	Neoprene Rubber	NO U.L.	Not rated	Y	-40	-	80	-40	-	176
429	EPDM Rubber	NO U.L.	Not rated	Y	-20	-	90	-4	-	194

An asterisk (\*) indicates data was not available at time of publication. Please see our website or contact your local Essentra Components Representative for the necessary documentation.

#### RAW MATERIAL SPECIFICATION/DISCLAIMER OF WARRANTY:

These Raw Material Specifications shall not be construed as creating an express warranty of description. The specifications are approximate and intended to serve only as guides and not as the basis of any sale, agreement or contract of goods sold by Essentra Components. Essentra Components Incorporated reserves the right to change the raw material on any of its goods contained in this catalog without notice to any buyer. Further, these Raw Material Specifications have been provided by the manufacturer and Essentra Components does not warrant their accuracy.

#### NYLON STORAGE GUIDELINES/SHELF LIFE:

All nylon parts are packaged in sealed plastic bags and contain an appropriate level of moisture. When stored in the original unopened bags at 73°F (23°C) and 50% RH, parts shelf life is one year from date of shipment.

RMS No.	Material Description	UL File No.	UL Flame Rating	RoHS Compliance	Material Temperature Range					
					°C			°F		
430	Rubber Adhesive / PE Foam	NO U.L.	Not rated	Y	-20	-	70	-4	-	158
431	Acrylic Adhesive/PE Foam/Silicone Coated Paper Liner	E327895	Not rated	Y	0	-	50	32	-	122
432	HDPE	NO U.L.	Not rated	Y	-20	-	60	-4	-	149
433	TPE	NO U.L.	Not rated	Y	-60	-	85	-76	-	185
434	Acetal	E36632	HB	Y	-40	-	105	-40	-	221
435	Nylon 6	E86034	V-0	Y	-40	-	119	-40	-	239
436	PVC, UV Stabilized	NO U.L.	Not rated	Y	0	-	50	32	-	122
437	Nylon 6/6	E70062	V-2	Y	-40	-	85	-40	-	185
438	Nylon 6	E47960	V-2	Y	-40	-	85	-40	-	185
439	PVC	NO U.L.	Not rated	Y	0	-	50	32	-	122
440	EPDM Rubber	NO U.L.	Not rated	Y	-20	-	90	-4	-	194
441	EPDM Rubber	NO U.L.	Not rated	Y	-20	-	90	-4	-	194
442	EPDM-CR-SBR	NO U.L.	Not rated	Y	-40	-	93	-40	-	199
448	PVC	E335039/192387	V-0	Y	0	-	50	32	-	122
449	LDPE	NO U.L.	HB	Y	-30	-	50	-22	-	122
450	PP	NO U.L.	Not rated	Y	-25	-	100	-13	-	212
451	PPA, 45% Glass Filled	NO U.L.	HB	Y	-	-	150	-	-	302
452	PVC	NO U.L.	Not rated	Y	-30	-	50	-22	-	122
453	PVDF	NO U.L.	V-0	Y	-	-	110	-	-	230

An asterisk (\*) indicates data was not available at time of publication. Please see our website or contact your local Essentra Components Representative for the necessary documentation.

#### RAW MATERIAL SPECIFICATION/DISCLAIMER OF WARRANTY:

These Raw Material Specifications shall not be construed as creating an express warranty of description. The specifications are approximate and intended to serve only as guides and not as the basis of any sale, agreement or contract of goods sold by Essentra Components. Essentra Components Incorporated reserves the right to change the raw material on any of its goods contained in this catalog without notice to any buyer. Further, these Raw Material Specifications have been provided by the manufacturer and Essentra Components does not warrant their accuracy.

#### NYLON STORAGE GUIDELINES/SHELF LIFE:

All nylon parts are packaged in sealed plastic bags and contain an appropriate level of moisture. When stored in the original unopened bags at 73°F (23°C) and 50% RH, parts shelf life is one year from date of shipment.

ESSENTRA COMPONENTS

## Conditions of Sale

BUYER'S ATTENTION IS DRAWN TO CONDITIONS 5, 11 and 12

### 1. General

- 1.1 The terms and conditions set out below (as amended from time to time by Seller by notice in writing to Buyer or by notice on Seller's Website), (the "Conditions") shall form part of every contract between Seller and Buyer for the sale and purchase of Products or Tooling (a "Contract") and shall apply to any dealings between Seller and Buyer to the express exclusion of any other terms and conditions (including any which Buyer purports to apply under any purchase order, confirmation of order, acknowledgement of delivery, Specifications or any such other documents or by endorsement upon the documents issued by Seller or otherwise).
- 1.2 No addition to, or modification of, any provision of these Conditions, or any representation, advice or recommendation relating to the Products given by any representative of Seller, shall be binding upon the parties unless made in writing and signed by an authorised representative of each of the parties with the intention of modifying or supplementing these Conditions being clearly expressed.

### 2. Interpretation

- 2.1 In these Conditions: "Buyer" means the person who purchases the Products from Seller; "Buyer's Tooling" means any die, mould, pattern, tool or other equipment, which is the property of Buyer and/or which was made, purchased or received by Seller from or at the direction of Buyer; "Custom Products" means any goods, other than Standard Products, supplied or to be supplied by Seller; "Group" means any subsidiary and any holding company of Seller and any subsidiary of any such holding company in each case from time to time; "Intellectual Property Rights" means all intellectual property rights including any patent (including supplementation protection certificates) utility model, rights in invention, copyright, rights in the nature of copyright, database rights, moral right, design right, registered and unregistered designs, registered and unregistered trademark, trade names and get-up, goodwill, know-how and confidential information (whether or not all or any of the same are registered and including all applications and rights to apply therefor) and anything analogous to any of the foregoing in any part of the world; "Losses" means all losses, claims, liabilities, costs, charges, expenses and damages of any kind irrespective of whether they were reasonably foreseeable or avoidable; "Order Acceptance" means a written acceptance of an order issued by an authorised signatory of Seller in accordance with condition 3.2; "Products" means any Standard Products and/or any Custom Products or any part thereof; "Sample" means, in relation to a sale by sample, the sample provided by Seller, subject to any tolerances or other variations reflected in any specifications or guidance notes supplied by Seller in relation to the sample, which an authorised signatory of Seller confirms is applicable to the Contract in the Order Acceptance; "Seller" means Essentra Components Pte Ltd, Essentra Malaysia Sdn Bhd, Essentra (India) Private Limited, Essentra FZE or Essentra Pty Ltd; "Seller's Catalogue" means Seller's product catalogue, as published by Seller from time to time including any catalogue on Seller's Website; "Seller's Tooling" means any dies, moulds, patterns, tools or other equipment other than Buyer's Tooling used or to be used in connection with the manufacture of the Custom Products; "Seller's Website" means [www.essentracomponents.com](http://www.essentracomponents.com) or any successor website; "Specifications" means: 2.1.1 in respect of Standard Products, the specifications for the relevant Standard Product as set out in the latest publication of Seller's Catalogue at the time such Standard Product is ordered; 2.1.2 in respect of Custom Products, the specifications for the relevant Custom Product which an authorised signatory of Seller has confirmed are the final specifications for such Custom Product; and 2.1.3 in the absence of any such specifications, the specifications that Seller may, acting reasonably, determine to be appropriate from time to time; "Standard Products" means any goods which are offered for sale by product number in Seller's Catalogue; and "Tooling" means Seller's Tooling and Buyer's Tooling.

- 2.2 In these Conditions: headings are for convenience only and shall not affect their interpretation; references to a "person" include any individual, company, corporation, firm, partnership, association, organisation, institution, trust or agency, whether or not having a separate legal personality; words in the singular shall include the plural and vice versa as the context admits or requires; any reference to any statute or statutory provision shall, unless the context otherwise requires, be construed as a reference to that statute or statutory provision as time to time amended, consolidated, modified, extended, re-enacted or replaced; and the word "including" shall, unless the context otherwise requires, mean "including without limitation".

### 3. Quotes and Orders

- 3.1 Quotes are valid for 30 days from the date of the quote, unless otherwise specified by Seller, but are not binding until an order is accepted by Seller in accordance with condition.
- 3.2 Each order for Products made by Buyer from Seller shall be deemed to be an offer by Buyer to purchase the Products specified in the order on the terms and conditions set out in these Conditions. An order is not binding on Seller until it is accepted by Seller issuing the Order Acceptance or (if earlier) by Seller either commencing manufacture of the Products or any related Tooling or samples, apportioning the Products to Buyer's order or dispatching the Products to Buyer.
- 3.3 Once accepted, an order may only be cancelled, varied or suspended by Buyer with the express prior written agreement of Seller.
- 3.4 The quantity and type of Products ordered shall be as set out in the order form or, if different, on the Order Acceptance.

### 4. Descriptions, Samples and Literature

- 4.1 All drawings, specifications and advertising issued by Seller and any descriptions, details or illustrations contained in any Seller's Catalogue are issued or published for the sole purpose of giving an approximate idea of the Products described in them and will not be relied on by Buyer or form part of the Contract except as provided in condition and condition.
- 4.2 Any typographical, clerical or other error or omission in any Seller's Catalogue, quote, price list, acceptance of offer, Order Acceptance, label, packaging, invoice or other document or information issued by Seller may be corrected by Seller, without liability to Buyer, at any time either by correcting any such matter in public or by publishing the correction on Seller's Website or by notifying Buyer in writing and such correction shall be binding upon Buyer forthwith.
- 4.3 Except as otherwise required by law, the Contract shall not be: (a) a sale by sample (even if samples have been provided) unless Seller expressly states on the Order Acceptance that the Contract is to be a sale by sample; or (b) a sale by description even if a description has been provided.

### 5. Specifications

- 5.1 Buyer will ensure that it undertakes adequate tests to ensure that where the Product meets the Specifications or, if applicable conforms to the Sample, in all material respects it is of satisfactory quality and fit for all of Buyer's purposes. Subject to condition, Buyer expressly acknowledges that, irrespective of any guidance provided to it by Seller, it is not relying on Seller's skill and judgement in determining whether the Products will be fit for all its purposes.
- 5.2 If Buyer wishes to rely on Seller's skill and judgement in relation to a Custom Product being fit for a particular purpose then prior to placing an order Buyer must expressly advise Seller in writing of the particular purpose and that it wishes to rely on Seller's confirmation rather than conducting its own testing. Seller shall advise Buyer of any additional charges which would apply if such confirmation is given. Buyer shall only be entitled to rely on the Custom Product being fit for that particular purpose if Buyer has provided all the information which Seller would need to undertake the requisite testing and an authorised signatory of Seller has expressly confirmed in the Order Acceptance that the Custom Product can fulfil that particular purpose.
- 5.3 Seller shall be entitled to make any changes to any Specifications which do not materially affect the quality or performance of the Products or, subject to notifying Buyer and at Buyer's cost, any material changes which Seller considers are required to be made to Custom Products to comply with any applicable statutory or European Community safety or other requirements. Seller shall not be responsible for ensuring that any Products comply with any applicable statutory or European Community safety or other requirements if the Specifications for such Products have been provided by, or developed or varied pursuant to a request of, Buyer.
- 5.4 In respect of any Specifications supplied to Seller by or on behalf of Buyer or variations to Specifications made at the request of Buyer and any Tooling either derived from any such Specifications or supplied by or on behalf of Buyer, Buyer warrants, represents and undertakes that such Specifications and/or Tooling: 5.4.1 fully and accurately reflect Buyer's requirements for the Products to be made pursuant to such Specifications or using such Tooling; 5.4.2 are complete and fit for the purpose of Seller producing and/or supplying (if agreed) Products complying with such Specifications and will result in Products which are fit for Buyer's purpose; 5.4.3 will not infringe the Intellectual Property Rights of any third parties and Seller, its Group and agents are entitled to use any Intellectual Property Rights comprised in such Specifications or Tooling or in any product or process described in the Specifications for the purposes of manufacturing the Products; and 5.4.4 will comply with all applicable laws and regulations.
- 5.5 Except as otherwise expressly provided in the Contract or agreed in writing between Seller and Buyer, Seller shall own all of the Intellectual Property Rights created by Seller, its Group or agents in the course of the performance of the Contract or otherwise in connection with the manufacture of the Products or the Tooling.

### 6. Tooling

- 6.1 If Seller agrees to supply Custom Products and it notifies Buyer that it requires Buyer's Tooling to do so, then Buyer shall either supply Buyer's Tooling capable of producing the Custom Products or, if agreed between the parties, Seller shall manufacture Buyer's Tooling or obtain it on Buyer's behalf at a price agreed between the parties and subject to having received payment in accordance with clause 6.2.
- 6.2 Following acceptance of Buyer's first order for the Custom Products to be manufactured using the relevant Buyer's Tooling and subject to receipt of Seller's invoice for such Buyer's Tooling, Buyer shall: 6.2.1 forthwith pay fifty percent (50%) of the whole price of such Buyer's Tooling and shall pay the remaining fifty percent (50%) of such price upon Seller sending samples produced using such Buyer's Tooling to Buyer; or 6.2.2 if requested by Seller, forthwith pay the whole price of such Buyer's Tooling.
- 6.3 Title to any Buyer's Tooling made or purchased by Seller shall remain with Seller until Seller has received the full price due in respect of such Buyer's Tooling in cash or cleared funds whereupon title shall pass to Buyer. Until title to Buyer's Tooling passes to Buyer the terms of conditions 10.3 and 10.4 shall apply to Buyer's Tooling on the same terms as they apply to the Products. Upon title to Buyer's Tooling transferring to Buyer, Buyer shall be entitled to a licence of the Intellectual Property Rights comprised in Buyer's Tooling to the extent necessary to use Buyer's Tooling to make the relevant Custom Products.
- 6.4 Risk of loss or damage to Buyer's Tooling supplied to, or purchased on Buyer's behalf by, Seller shall remain with Buyer. Risk of loss or damage to Buyer's Tooling made by Seller shall pass to Buyer upon completion of its manufacture. Buyer shall ensure that Buyer's Tooling is appropriately and adequately insured with a reputable insurer for so long as it remains at Seller's premises and will bear the costs of any necessary repairs or replacement.
- 6.5 Seller shall notify Buyer of any loss or damage to Buyer's Tooling whilst in Seller's possession. Seller, its Group or agents shall have no liability to Buyer in respect of any loss or damage to Buyer's Tooling whilst such Buyer's Tooling is in their possession of Seller except to the extent caused by their negligence or intentional damage.
- 6.6 Seller shall store Buyer's Tooling free of charge for a period of 2 years from the date of last delivery of Products made using Buyer's Tooling. On expiry of this period, Seller may use for its own purposes or continue to store, return or destroy Buyer's Tooling, the cost of which shall be payable by Buyer.
- 6.7 Where Buyer has indicated that it wishes to purchase a minimum quantity of Custom Products and is aware that Seller will invest or has invested in the manufacture of Seller's Tooling in respect of those Custom Products and Buyer orders or takes delivery of a smaller quantity of such Custom Products than the minimum it previously indicated then Seller may invoice Buyer, pro rata to the quantity of such Custom Products ordered, for the cost of its investment in such Seller's Tooling and for its reasonable administration and handling charges.
- 6.8 The Intellectual Property Rights in and title to any Seller's Tooling shall remain at all times with Seller except as otherwise expressly agreed in writing. If Buyer purchases Seller's Tooling, then title and risk in Seller's Tooling shall pass to Buyer upon payment in full by Buyer of an amount notified by Seller in writing. Buyer acknowledges that any Seller's Tooling which it purchases will have been used by Seller and that Buyer shall be entitled on reasonable notice to inspect it prior to purchasing it and shall be deemed to have satisfied itself that it is of satisfactory quality and fit for its purposes. Upon title and risk in any Seller's Tooling passing to Buyer it shall thereafter be treated as Buyer's Tooling for the purposes of these Conditions.

# Terms and Conditions

- 6.9 If Seller is required to redesign, repair or replace or otherwise incur any expenditure in relation to any Tooling for use in producing Custom Products, Buyer shall promptly reimburse Seller for all such costs incurred by Seller, including any tooling and re-tooling costs, except to the extent such costs were caused by Seller's negligence or wilful abuse.
- 6.10 Seller shall be entitled to utilise the Tooling for any purpose at its discretion including for the purpose of manufacturing the Custom Products.
- 7 Price**
- 7.1 Subject to condition, the price of the Products or the Tooling shall be the price specified in the applicable quote or, in the absence of an applicable quote, the price set out in Seller's price list in force as at the time the order is accepted (the "Price"). The Price is inclusive of standard packaging in accordance with Seller's current practice. The Price reflects the limitations on liability set out in these Conditions but, if requested by Buyer, Seller will advise Buyer of the additional costs which would apply if Seller agrees to any variations to such limitations on liability.
- 7.2 Seller reserves the right, by giving notice to Buyer at any time before delivery, to increase the Price to reflect any increase in the cost to Seller of supplying any Products or Tooling which is due to: 7.2.1 any factor beyond the reasonable control of Seller; 7.2.2 any increase in the cost of labour or materials including any storage costs if the Products are not collected or delivered in accordance with the Contract; 7.2.3 any variation requested by Buyer to delivery dates, quantities, Specifications or the scope of Seller's instructions; 7.2.4 any delay or additional work or materials caused by any instructions, neglect or default of Buyer; or 7.2.5 any failure of Buyer to procure the supply to Seller of adequate and timely information, instructions, specifications or, if applicable, Tooling.
- 7.3 The Price is exclusive of any applicable value added tax or other taxes or duties and of all costs and charges in relation to non-standard packaging, loading, unloading, carriage and insurance or similar costs, which (if any) shall be paid in addition by Buyer at the time it is due to pay for the Products or the Tooling. Where carriage or other costs to be borne by Buyer are initially paid by Seller, Seller shall be entitled to render an invoice forthwith in respect of such costs.
- 8 Payment**
- 8.1 Seller shall at its discretion be entitled to invoice Buyer for payment of the Price or any other amounts payable by Buyer in advance.
- 8.2 Seller shall be entitled to: 8.2.1 offer and withdraw credit accounts at any time; 8.2.2 request references and make credit reference searches in relation to Buyer.
- 8.3 Subject to condition, payment of any Seller's invoice is due (without deduction, discount, abatement or set-off) within 30 days of the date of the invoice, notwithstanding that delivery may not have taken place or that property in the Products or the Tooling has not passed to Buyer. Unless otherwise expressly agreed by Seller, payment shall be made in the same currency as the Price. The time of payment of sums due from Buyer shall be of the essence of these Conditions. No payment will be deemed received until received by Seller in cash or cleared funds. Interest will be payable on overdue amounts at the rate of 3% percent per annum above the Lloyds TSB Bank Plc base rate from time to time.
- 8.4 If any sums are not paid on or before the due date for payment, interest will accrue on the amount unpaid until payment in full is made (both before and after any judgment). The parties agree that the provisions of this condition provide a substantial contractual remedy for the late payment of sums due pursuant to these Conditions.
- 8.5 If Buyer fails to make any payment when due pursuant to these Conditions and/or pursuant to any other contract between Buyer and Seller in accordance with its terms then, without prejudice to any other right or remedy available to Seller, Seller shall be entitled to: 8.5.1 terminate the Contract or any other contract between Buyer and Seller; 8.5.2 deduct outstanding sums from any sums owed by Seller to Buyer under the Contract or otherwise; 8.5.3 require Buyer to pay any costs of storage of the Products and any Tooling; 8.5.4 suspend any further deliveries to Buyer under the Contract or any other contract until paid; 8.5.5 treat the Contract as repudiated and terminated; 8.5.6 resell any Products not yet delivered to Buyer; and/or 8.5.7 retain any sums paid as deposit for the Products.
- 9 Delivery**
- 9.1 Unless otherwise agreed in writing, Products will be sent to Buyer by a carrier service chosen by Seller, acting reasonably. Delivery of the Products to Buyer shall be effected by Seller delivering them to the carrier or by collection by the carrier. Thereafter, transport of such Products shall be subject to the carrier's conditions which shall be notified to Buyer, if requested. Seller may deliver early or inform Buyer. Seller shall be no obligation under laws and regulations.
- 9.2 Where it is agreed in writing that the Products shall be delivered by a method other than that referred to in condition then delivery shall be effected: 9.2.1 where the Products are to be collected by Buyer from Seller's premises, by Seller notifying Buyer that the Products are ready for collection; 9.2.2 where the Products are delivered by Seller, by Seller delivering the Products to the address nominated by Buyer for delivery; or 9.2.3 where the Products are to be transported by a third party, by collection by or delivery to that third party of the Products.
- 9.3 Any periods of time or dates quoted for delivery of the Products are approximate only. Time for delivery shall not be of the essence. Seller shall not be liable for any delay in delivery of the Products. Seller may deliver up to 10 per cent. more or 10 per cent. less than the quantity of Products specified in the order and Buyer shall accept such variation in quantity and shall pay the Price as adjusted to reflect such variation in quantity.
- 9.4 Seller shall not be responsible for any Losses incurred or suffered by Buyer as a result of a failure to deliver the Products or for short delivery unless Buyer has informed Seller in writing within ten working days from the estimated date of delivery in relation to a failure to deliver or the actual date of delivery in relation to a short delivery. In any event, subject always to condition, where for any reason Seller is so liable, Seller's liability shall be limited to: 9.4.1 the amount by which the price in the cheapest available market of similar goods to replace those not delivered exceeds the Price of the Product not delivered; or 9.4.2 if there is no such market, an amount equal to the Price applicable to the Products not delivered.
- 9.5 Where the Products are to be delivered in instalments, each delivery shall constitute a separate obligation and neither any failure by Seller to deliver nor any claim in respect of any one or more instalments by Buyer shall entitle Buyer to treat the Contract as a whole as repudiated.
- 9.6 Where Buyer fails to take delivery of the Products or fails to give Seller adequate delivery instructions in advance of the time stated for delivery (otherwise than by reason of any cause beyond Buyer's reasonable control or by reason of Seller's neglect or default) then the Products shall be deemed to have been delivered at the time stated for delivery and, without prejudice to any other right or remedy available to Seller, Seller may: 9.6.1 store the Products until actual delivery and charge Buyer for the reasonable costs (including insurance) of storage, if applicable but without any obligation on Seller to procure insurance; or 9.6.2 where Buyer has failed to take delivery of the Products on or before the fifth working day following the intended day for delivery, sell the Products at the best price readily obtainable and (after deducting all reasonable storage and selling expenses) shall account to Buyer for the excess over the Price or invoice Buyer for any shortfall below the Price.
- 9.7 If, upon delivery of the Products, Buyer discovers that it has incorrectly ordered those Products, Seller's standard handling charge from time to time will be payable by Buyer if Seller agrees (at its sole discretion) to accept return of those Products.
- 10 Risk and Property in the Products**
- 10.1 Products supplied by Seller shall be at Buyer's risk immediately on and after delivery and so Buyer should arrange appropriate insurance from that point.
- 10.2 Title (legal and beneficial) in all Products supplied or sold by Seller shall be retained by Seller until the earlier of: 10.2.1 Seller having received in either cash or cleared funds all sums due in respect of the Products and on any account whatsoever from Buyer to Seller; or 10.2.2 (on an item by item basis) the Products having been used or incorporated into other products.
- 10.3 Until such time as the property in the Products passes to Buyer, Buyer must: 10.3.1 hold such Products (on a fiduciary basis for and on behalf of Seller) as Seller's bailee and act in good faith to protect Seller's interests in the Products; 10.3.2 store such Products (at no cost to Seller) separately from all other goods of Buyer in such a way that such Products remain identifiable as property of Seller and shall not mix them with any other goods; 10.3.3 not pledge or allow any lien, charge, or other interest to arise over the Products or their documents of title; 10.3.4 not destroy or deface any identifying marks on such Products or relevant packaging and maintain such Products in satisfactory condition; and 10.3.5 keep such Products insured on Seller's behalf and in the event of any claim hold the proceeds of such insurance on trust for Seller.
- 10.4 Seller shall be entitled at any time to require Buyer to deliver up any Products to Seller prior to property in the Products passing to Buyer. Buyer grants Seller and its agents an irrevocable licence at any time to enter any premises where such Products are stored to inspect or, if Buyer has failed to deliver up possession when requested by Seller, to repossess such Products.
- 11 Quality**
- 11.1 Subject to the remaining provisions of these Conditions; Seller warrants that on delivery: 11.1.1 all Products and Buyer's Tooling will be of satisfactory quality; and 11.1.2 where Seller has issued a confirmation in relation to fitness for a particular purpose in accordance with condition, the Products will be reasonably fit for that particular purpose. Buyer expressly agrees that a Product will be deemed to be of satisfactory quality and fit for its purpose if (a) in relation to a sale by sample, the Product complies with the Sample in all material respects; or (b) in all other cases, the Product complies with its Specifications in all material respects.
- 11.2 The warranties contained in condition shall not apply unless: 11.2.1 in respect of defects that are apparent on inspection of the Products or Tooling, Buyer notifies Seller, in writing, setting out in reasonable detail the nature of the breach of warranty within fourteen days after the delivery of the Products; or 11.2.2 in relation to defects that are not apparent on inspection of the Products or Tooling, Buyer notifies Seller in writing setting out in reasonable detail the nature of the breach of warranty within 14 days after the defect became apparent or ought to have become apparent to Buyer, and in any event within 12 months of the date of delivery of the Products; and 11.2.3 after receiving such notice of the defect, Seller is given reasonable opportunity to inspect the Products or Tooling and, at Seller's request (acting reasonably), the Products or Tooling are returned to Seller's place of business for the purposes of such inspection; and 11.2.4 the total price for the Products has been paid by Buyer.
- 11.3 Seller shall not be liable for any breach of any of the warranties in condition if: 11.3.1 the Product conforms to its Specifications, or if applicable Sample, in all material respects; 11.3.2 the breach was caused directly or indirectly by Buyer's breach of condition or by Buyer's Tooling, except to the extent caused by Seller's negligent actions or omissions in respect of the manufacture or use of Buyer's Tooling; 11.3.3 the breach was caused directly or indirectly by the acts or omissions of any persons not expressly authorised by Seller, including repairs, additions or changes made to the Products by or on behalf of Buyer; 11.3.4 the breach was caused directly or indirectly by parts, materials or equipment incorporated into a Product but not manufactured by Seller, in respect of which Buyer shall only be entitled to the benefit of any such warranty or guarantee as was given by the manufacturer to Seller and which is capable of being assigned to Buyer (at Buyer's cost); 11.3.5 Buyer makes further use of or resells the Products after giving notice of a defect or fails to comply with Seller's reasonable instructions in relation to a product hold or recall; or 11.3.6 the breach was caused directly or indirectly by environmental conditions or use or storage or handling of the Products outside the parameters of its Specifications or instructions supplied by Seller or by any matter specifically excluded by Seller by notice in writing including carelessness, mishandling, operating errors, vandalism or unforeseen events.
- 11.4 Subject to conditions and, where Products or parts thereof returned to Seller are found, in the reasonable opinion of Seller, not to conform with the warranty contained in condition or any other warranties, quality standards or conditions implied by law, Seller shall discharge any liability in full by, at its sole discretion, repairing or replacing the whole or part of all or any of the Products or refunding the Price of the non-conforming Products. Any Products which have been so replaced shall be owned by Seller.
- 11.5 Subject to the provisions of condition, the warranties contained in condition shall be the sole extent of Seller's liability arising out of or in connection with the Products.
- 11.6 Buyer shall comply with all reasonable instructions of Seller in relation to any product hold or product recall campaign organised in respect of the Products or any other corrective action reasonably taken by or on behalf of Seller in respect of the Products after delivery to Buyer.
- 12 Limitation of Liability**
- 12.1 For the purposes of this condition 12: 12.1.1 "Claim" means a claim arising out of or in connection with the supply of any Products or Tooling to Buyer or as a result of breach of these Conditions or of any duty of any nature whatsoever by Seller or pursuant to any use made by Buyer or resale by Buyer of any Products (or of any product incorporating any of the Products) or of any Tooling or as a result of any representation, statement, act or omission including negligence arising under or in connection with these Conditions or the Contract; 12.1.2 "Claim Limit" means, in respect of any calendar year, the greater of: 12.1.2.1 the aggregate amount

- payable to Seller by Buyer for goods of the type that are the subject of the Claims purchased by Buyer from Seller in that year (the "Relevant Goods"); 12.1.2.2 in the first three months of that year, the aggregate amount payable by Seller to Buyer for the Relevant Goods purchased in the previous year; or 12.1.2.3 where no Relevant Goods were purchased in the previous year or the Claim does not relate to the purchase of goods, to an aggregate sum of (a) where the Relevant Goods are exclusively Standard Products, £50,000; or (b) where the Relevant Goods include Custom Products or Tooling, £100,000.
- 12.2 Without prejudice to conditions and, Seller's aggregate liability (including any liability for the acts or omissions of its employees, agents, sub-contractors or other members of its Group) to Buyer for all Claims whether arising in contract, tort (including negligence or breach of a statutory duty), misrepresentation, restitution or otherwise shall be limited as follows: 12.2.1 Seller's aggregate liability for a Claim in relation to any single item of Product shall be limited to the Price payable to Seller by Buyer for that item; 12.2.2 Seller's aggregate liability for a Claim in relation to any item of Tooling shall be limited to the depreciated value of such item or its replacement price, whichever is the lower and 12.2.3 Seller's aggregate liability to Buyer for all Claims arising in each calendar year shall be limited to the Claim Limit.
- 12.3 Without prejudice to condition 12.6, where a Court adjudicates that the exclusion of liability in condition is for any reason unenforceable, Seller's liability for the matters described in condition or, arising pursuant to the sale and purchase of the goods, tooling and related matters, shall be limited in respect of all Claims arising in any calendar year to the greater of: (a) the aggregate amount payable to Seller by Buyer in respect of the Products or Tooling to which any of the Claims relate; or (b) where the Claims relate exclusively to Standard Products, £100,000 and where the Claims do not exclusively relate to Standard Products, £200,000; in each case in aggregate in that calendar year.
- 12.4 Seller shall not be liable to Buyer or any other party for any (a) indirect Losses, (b) economic loss, (c) loss of profits or anticipated profits, (d) loss of expected future business, (e) damage to reputation or goodwill, nor (f) any claim for consequential compensation whatsoever (however caused), which arises in connection with the supply of Products or Tooling or related services by Seller, in each case whether direct or indirect or consequential and, whether such losses are suffered by Buyer or by any other party.
- 12.5 Subject to condition, unless otherwise expressly provided in these Conditions all implied warranties, terms and conditions are excluded from the Contract to the fullest extent permitted by law and Seller will not be liable to Buyer for any loss of any kind whatsoever which arises out of the breach of implied warranties, terms or conditions, or breach of any duty of any kind imposed on Seller by operation of law.
- 12.6 If Buyer becomes aware that any third party has made or appears likely to make any claim in respect of the Products (including, without limitation, as to defects in them or rights infringed by them) it shall: 12.6.1 promptly notify Seller of such claim or circumstance; 12.6.2 promptly provide such assistance to Seller and take such action as Seller may request to avoid, dispute, defend, mitigate, resist, appeal or compromise such claim or circumstance including but not limited to allowing Seller to take full control of any proceedings or negotiations in connection with the claim; and 12.6.3 not settle or compromise, make any admissions, nor agree any matter in the conduct of any dispute, without the prior written approval of Seller.
- 12.7 Without prejudice to any other provision of these Conditions, Seller will not be in breach of the terms of the Contract for any delay in performing, or failure to perform, its obligations under the Contract if that failure or delay was due to any cause or circumstance beyond Seller's reasonable control, which shall, without limiting the generality of the term, be deemed to include war or other action of military forces, terrorism, riot, civil commotion, sabotage, vandalism, accident, break down or damage to machinery or equipment, fire, flood, acts of God, strike, lock-out or other industrial disputes (whether or not involving employees of Seller) or shortage of materials at the market rates existing when the Agreement is made, legislative or administrative interference or was due to any failure, neglect or delay on the part of Buyer or its agents or representatives.
- 12.8 Seller reserves the right to defer the date of delivery or to terminate the Contract or reduce the volume of the Products ordered by Buyer (without liability to Buyer) if it is prevented from or delayed in the carrying on of its business due to an event referred to in condition occurring, provided that where the event in question continues for a continuous period in excess of 30 days either party shall be entitled to give notice in writing to the other to terminate the Contract with no liability due to or by either party.
- 12.9 Buyer acknowledges that the limitations of liability set out in these Conditions are reasonable and reflect the commercial intentions of the parties in the context of the anticipated earnings of Seller under the Contract and any other contracts and the ability of Buyer to protect itself through insurance. Seller may be willing to vary the limitations on liability in relation to specific Products if requested by Buyer subject to Buyer bearing the additional costs as notified to it by Seller. For the avoidance of doubt, any payment made by Seller to Buyer in any calendar year in respect of any Claim made by Buyer pursuant to any contract or otherwise shall operate to reduce the amount of the Claim Limit, and the limit of liability set out in condition, which is available for further Claims in that calendar year.
- 13. Termination**
- 13.1 Without affecting any other rights and remedies it may have, Seller may terminate the Contract forthwith if: 13.1.1 Buyer breaches any terms of any contract with Seller; 13.1.2 Buyer makes any composition or voluntary arrangement with its creditors or any step, application, order, proceeding or appointment is made or taken by or in respect of Buyer (including, without limitation, the making of an application or the giving of any notice) by Buyer or any other person for a distress, execution, winding up, dissolution, or to appoint an administrator of Buyer or (being an individual or firm) becomes bankrupt or (being a company) goes into liquidation (otherwise than for the purposes of a solvent amalgamation or reconstruction); 13.1.3 an encumbrance takes possession, or a receiver (administrative or otherwise) is appointed, of any of the property or assets of Buyer; or Buyer ceases, or threatens to cease, to carry on business; or 13.1.4 Seller reasonably apprehends that any of the events mentioned in conditions to above is about to occur in relation to Buyer and notifies Buyer accordingly.
- 13.2 Buyer may, on 30 days written notice, terminate: 13.2.1 the Contract within 30 days of receiving notice from Seller pursuant to conditions or that the Price of the Products which are the subject of the Contract is increasing by more than 10% of the original Price specified in applicable to the Products at the time the Contract is concluded; or 13.2.2 that part of the Contract relating to Custom Products on 30 days written notice if it does not wish (acting reasonably) to accept the changes to the Specifications of the Custom Products notified by Seller pursuant to condition.
- 13.3 Where Seller terminates the Contract in accordance with conditions or then, without prejudice to any other right or remedy available to Seller: 13.3.1 Seller shall be entitled to terminate any other contract or suspend any further deliveries under the Contract or any other contract; 13.3.2 where the Products have been delivered, but not paid for, subject to condition, Buyer's right to possession shall terminate and Seller may dispose or use any of the Products as it wishes; and 13.3.3 the Price shall become immediately due and payable notwithstanding any previous agreement or arrangement to the contrary.
- 13.4 Termination of the Contract, for whatever reason, shall not affect any of its provisions which are intended to continue to have effect after it has come to an end, including conditions 6, 10, 11, 12, 13, 14 and 15.
- 14. Indemnity**
- 14.1 Without prejudice to Seller's other rights and remedies, Buyer shall indemnify and keep indemnified Seller, its Group and their employees and agents on demand in full against any Losses incurred or suffered as a result of: 14.1.1 cancellation, variation or suspension of an order by the Buyer pursuant to condition 3.3; 14.1.2 any claim brought by any third party in respect of Losses, injury or damage caused by the Custom Products or Buyer's Tooling or by any Products which, following delivery, have been subjected to any use other than the authorised use for such Products (being the use for which such Products are commonly supplied or a use expressly authorised in accordance with condition) or modified or repaired by a person other than Seller or any event has occurred (including any act or omission) which would result in condition ceasing to apply to those Products; 14.1.3 the use of Specifications or Tooling supplied by or on behalf of Buyer or modified at the request of Buyer; 14.1.4 any breach of condition 5.4 and any claims by any third party in relation to any infringement or alleged infringement of any of its Intellectual Property Rights as a result of the use, possession or supply of any Custom Product or any Specifications and/or Tooling supplied by or on behalf of or modified at the request of Buyer; and 14.1.5 any termination pursuant to conditions 8.6 or 13.1.
- 15. Miscellaneous**
- 15.1 Seller may perform any of its obligations or exercise any of its rights hereunder by itself or through its subcontractors or agents or any member of its Group. Any act or omission of any such subcontractor or agent or member of its Group shall be deemed to be the act or omission of Seller and shall be subject to the exclusions or limitations on liability set out in these Conditions. Buyer shall not transfer, assign or sub-contract any of its rights or obligations under the Contract without Seller's prior written consent and in any event shall remain responsible for the performance of the Contract by any transferee, assign or sub-contractor.
- 15.2 Any notice shall be in writing addressed to the other party at, in the case of Seller, Essentra Components Pte Ltd, 238A Thomson Road #25-04/05 Novena Square Singapore 307684, (65) 6841 5481 or Essentra Malaysia Sdn. Bhd, D5-5-6, Solaris Dutamas 1 Jalan Dutamas 1, 50480 Kuala Lumpur, Malaysia, (60) 3 6207 3232 or Essentra (India) Private Limited No. 3 (Old Plot nos. 18 & 23) 3rd Main Road Peenya Industrial Area, Phase 1 Yeshwantpur Hobli Bangalore 560 058 India, (91) 0 80 4545 3618 or Essentra FZE, PO Box No 261392 Plot No. S20403 Jebel Ali Free Zone (JAFZA) Dubai United Arab Emirates, (971) 4 8806919 or Essentra Pty Ltd 503 Victoria Street Wetherill Park NSW, 2164 Australia, (61) 02 96844521 and in the case of Buyer at its registered address or such other address as may at the relevant time have been notified to Seller. Hand delivered notices shall take effect immediately, postal notices, two working days after posting by first class post and, if sent by fax, at the date and time on the sender's transmission acknowledgement slip or (if lost) on receipt.
- 15.3 No waiver by Seller of any breach of the Contract by Buyer shall be considered as a waiver of any subsequent breach of the same or any other provision. Failure by Seller to enforce any term of the Contract shall not be waiver of Seller's rights.
- 15.4 If any provision of the Contract is held by any competent authority to be invalid or unenforceable in whole or in part, the validity of the other provisions of the Contract and the remainder of the provision in question shall not be affected thereby.
- 15.5 The Contract contains the entire agreement and understanding of the parties and supersedes all prior agreements, understandings or arrangements (both oral and written) in respect of the Products (save that neither party seeks to exclude liability for fraudulent pre-contractual misrepresentation upon which the other party can be shown to have relied).
- 15.6 The Contract shall be governed by the laws. Any dispute shall be referred to the exclusive jurisdiction of the Courts save that Seller shall retain the right to bring proceedings against Buyer in any other court.
- 15.7 Save in respect of the rights, indemnities or warranties expressly stated to be given in favour of the Group, or Seller's agents, all of which shall accrue directly for their benefit, the parties to the Contract do not intend that any term of the Contract will be enforceable under the Contracts by any person that is not a party to it. No such person shall have any rights relating to any extension, waiver and/or amendment to the Contract including but not limited to, any rights to approve any extension, waiver and/or amendment to the Contract.

# Alphabetical Index

## C

PAGE NUMBER

### CABLE TIES & CABLE MANAGEMENT

#### Cable Glands

Atex	270
Brass	269
Covers	274
EMC	272
Spiral	267
Stainless Steel	269
Locknuts and Sealing Washer	267
Multi Slot	271
Nylon	274
Vent Plugs	256

#### Blanking Plugs

Blanking Plugs	261
Body	261
Domed	259
Hole Plug	248
Liquid Tight	260
Push In Cable	295
Open/Closed Bushes	258
Open Snap	259
Round Hole	248
Snap-Fit	260
Snub Bushes	258
Thread	251
Universal Bushes	258
Vent Plugs	273

#### Cable Ties and Accessories

Adhesive/Screw Mount	171
Adhesive Tie Mount	182
Bead Lanyard Hank Tie Base	184
Beaded	167-168
Belt	173
Blind Hole Mount	172
Cable Tie Holder	182-183
Chasis	165
Clamps	191-193, 195, 218, 226, 232, 239
Clips	239
Coloured	161
Cupped	172, 181
Double Locking	165
Double-Loop	164
Elastomer Strap	174
Hanking	168
Heat Stabilized	163
Installation Tools	165
Kurly Lock	185-187, 189
Kwik Wrap	175-176
Marker Tag	173
Nylon	164
Plug in Cable Hanger	228
Push Mount	169-171, 179-180
Releasable with Flat Holder	164
Rivet Mount	173
Screw Mount	177-178
Stainless Steel	166

Standard	161
Standard Cleats	226
Tape on Cable Holder	225
Twist Lock	185-190
Universal Mounting Block	225
Universal Mounting Strap	174
Wire Saddle	190, 200, 216, 253-254
Wrap-It	164

#### Conduit

Clips	184
Hinged Locking Clamps	239
Sleeving	240-241
Wrap	239-240

#### Grommets

Angular Hole	247
Cable	255
Channel	251
Continuous	249
Diaphragm	245
Duro-Strip	251
Edge Wire Saddle	253-254
Grommets	243
Hole	247
Imperial	243
Membrane Entry	248
Metric	244
Quick-Fit	245
Moulded	252
Rubber Edge	251
Rubber Cushion	248
Seal	249
Snap-Fit	260
Stepped	247

#### Strain Relief

Bushes	258, 262-265
Clamp	265
Self-Lock	262
Split Panel	262

### CAPS AND PLUGS

#### Push Fit Caps

Connector Caps	23
Driveshaft Protection Caps	18
Elastomer Lanyard	25
Flanged Caps	23, 27
Flexicaps	20-21
Grease Nipple Caps	27
Heat Shrink End Cap	19
Mini Flange Stud Protection Cap	27
Moss Caps	25
Multi-Flex Cap	19
Non-Threaded End Cap	24
Pull-Tab Cap	24
Quick Fit/Release Caps	19, 26
Ribbed Caps	15
Stud Caps	22
Tear Tab Caps	24

#### Push Fit Plugs

Barrel Plugs	11-12
Ezeplugs	17
Gas Cylinder Valve Protection	15
Flangeless Plugs	16
LPG Caps / Plugs	14
Moss Plugs	13
Moss Pull Plugs	18
Parallel Protection Plugs	13
POL Valve Seal	14
Ribbed Tube Plugs	17

#### Tapered Caps/Plugs

Caps/Plugs	1-9
Centre Pull Plug	8
Push-In Plugs	10
Side Pull Tab	9
Snap-Fit Plug	10
Tapered Caps / Plugs	3-9
Tapered Plug with Ring Tab	9
Wide Flange Heavy Duty Caps / Plugs	7
Straight Pull Plugs	10

#### Threaded Caps 37-38

#### Threaded Plugs

Anti-Vibration Plug	34
BSP Threaded Plugs	30
Hose Washer Cap	30
NPT Threaded Plugs	30, 36
O-Ring Threaded Plugs	36-37
Pipe Plug	28
Slottex Plugs	33-34
Square Headed Plugs	28
Threaded Plugs	29-32
Threaded Sealing Caps	39-41

### CARD GUIDES AND PULLER

#### Level Ejectors

Card Ejector	152
PCB Inserter/Extractor Installation Pin	152

#### Mounting

Circuit Board Guide	145
PCB Mounting Block	146
Vertical Mount Guide	143-146

#### Slotted Guides and Pullers

Card Guides	143-145
Circuit Board Puller	149

#### Special Slotted Guides

Card Guide	149-151
PCB Inserter/Extractor	151-152

### CIRCUIT BOARD HARDWARE

#### Dual Locking Spacers

Circuit Board Support	91-99
Key Slot with Locking Bayonet Nose	103-105
Sheet Edge Insert	103
Support Post	99-103
Touch Control Spacer	104
Vibration and Shock Dampening	98

## Insulators

Ceramic Spacer	136
Heat Sink Spring Mount Rivet	136
Quick Fit Fuse Cover	139
Screw Insulator	139
Sleeve Insulator	139
Snap in Bearing	140
Transistor Cover	137
Transistor Insulator	137-138
Voltage Insulators	134-135

## Push Spacers

Push Spacer on Adhesive Base	105
Push Spacers	106-109
Sprung Spacers	105

## Reverse Locking Spacers

Circuit Board Push Spacer	108
Circuit Board Support	109-123

## Specialist Spacer

Circuit Board Stacking Spacer	134
Circuit Board Support	91-123
Collar Space	117
Grommet	116
Mini Support Post Self Threading	101
PCB To Facia Panel Mounting	103
Rivet Based Spacer	103
Screw Fastened Spacer	120
Self-Retaining Spacer	116-117
Spacer Nut	119
Toggler Fixer	118
Universal Board Mount	114

## Threaded/Metal Spacers

Circuit Boarding Stacking Spacer	134
Circuit Board Support	123-125
Hexagonal Spacer	125-126
M/F Threaded Spacer	125
Pre-mounting Foot	125
Round Spacer	130
Standing Capacity Holder	129
Threaded Standoff	124, 131-133

## E

PAGE NUMBER

### EMI SUPPRESSION FERRITE CORES

## Flat Cable Cores

Flat Cable Sleeve Cores	300-301
Ribbon Cable Split Cores	298

## Inline Beads

Multiline Suppressor Beads	304
Wound Beads	305-306

## Round Cable Cores-Sleeve

Sleeve Cores	282-289
--------------	---------

## Round Cable Core-Split

Cable Suppression Cores	278-281
-------------------------	---------

## Toroid Cores

Toroid Cores	290-297
--------------	---------

## F

PAGE NUMBER

### FAN ACCESSORIES

## Fan Guards

Meted Fan Guard	324
Fan Gasket	324

## Fan Mount Accessories

Fan Mount	325-328
Fan Mount Gasket	325
Fan Mount Rivet	328
Snap Rivet	328

## Filters

Fan Filters	323
Metal Filter Frame	323

### FASTENERS AND FIXINGS

## Barbed and Push-Fit Fasteners

Barbed Fasteners	384-391
Press Fit Pin	387
Push-in Fasteners	388
Snap Button	387
Snap Lock Pin	388
Xmas Tree Clip Fasteners	386

## Binder Screws and Snap Fasteners

Assembly Clips	392
Barbed Rivet	393
Book Screws	393
Binder Screws	394
Snap Fasteners	394
Push Clips	395

## Screws and Nuts

Countersunk Screw	344
Crossed Pan Head Tapping Screws	356
Dome Nuts	370
Flanged Hexagonal Screws with Internal Star Drive	356
Fly Nuts	369
Grub Screws	365
Hexagonal Head Screw	345-346
Hexagonal Nuts	366-368
Hexagon Bolt	346
Knurled Nuts	368
Knurled Screws	363
Kwik Nut Fastener	369
Nylon Metric Screw	353
Pan Head Screw	347, 353, 356-357
Pawl Locks	364
Self-Locking Nuts	366
Slotted Screw	347-352
Socket Head Screws	362
Threaded Rod	365
Thumb Screws	362-363
Transparent Nut	367
Transparent Screw	358
Washer Nuts	366
Wing Nuts	369

## Rivets and Panel Fasteners

Arrow Clips	382
Blind Rivets	375
Drive Fastener	382
Folding Leg Rivets	375
Grommet Nuts	375
Keyhole Clips	382
Mounting Buttons	383
Push Lock Rivets	376
Push Rivet	372-378
Quarter Turn Latches	373
Quarter Turn Panel Fasteners	373-374
Quarter Turn Plug Blanking Plug	376
Removable Rivet	371
Rivet Hand Tool for Push Rivets	372
Screw Rivets	376
Screw Rivets Fasteners	376
Snap Fasteners	379
Snap Latch	381
Snap Lock Pin with Arrowhead	371
Snap Rivet	377-378

## Washer, Spacers and Bushes

Bushes	341
Fixing Rings	339
Insulation Sleeves	340
Plastic Hose Clamps	339
Retaining Rings	339
Screw Insulators	336
Spacers	342-347
Washers	337-339

### FEET AND CASTORS

## Adjustable Feet

Adjustable Feet	602-606
Adjustable Glides	605
Adjustable Tilt Glides	604
Height Adjusters	605
Leveling Foot	601
Stainless Steel Feet	603

## Furniture Feet

Gripneck Feet	607
Rivet Feet	610
Rubber Fixed Foot	606

## Machinery Feet

Anti-Vibration Machine Mount	600
Fixed Stud Leveling Foot	601
Low-Profile Bolt Down Leveling Feet	601
Machinery Mounting Feet	598
Pressed Steel Bolt Down Feet	600
Standard Machine Feet	599
Vibration Dampening Machine Feet	600

## Saddle and Insert Feet

Angled & Flat Bar Feet	621
Stand-Off Feet	621

## Self-Adhesive, Screw-on Feet and Bumpers

Anti Slip Pad	614
---------------	-----

# Alphabetical Index

Barbed Mount	612
Big Foot	615
Bumper	616-617
Fast Foot	609-610
Grommet Feet	612
Insert Foot	611
PTFE Glider Adhesive Fixing	613
Push on Feet	611
Rubber Foot Snap IN	616
Screw-on Feet	608
Shock & Vibration Dampening Foot	615
Snap Rivet Mount	612
Stick-on	614, 618

## Tiltserts, Buffer and Glides, Castor

Saddle Bases	620
Saddle Feet	620-621
Stacking Buffers	619
Twin Wheel Castor	623

## FIBRE MANAGEMENT

### Fibre Clips and Supports

Coupler Clip	310
Fibre Clips	311
Isolator Clips	310
Micron Fibre	313
Mounting Saddle	313
Network Saddle	313
Optical Fibre Bracket	316
Optical Fibre Expandable Bracket	315
Optical Fibre Holder	312
Splice Holder	309
Support Base	314

### Fibre Clips and Plugs

Bend Limiting Tubing	317
Bend Limiting Tubing Clip	317
Blanking Plug	319
Connector Cutout Adaptor	316
Connector Plug	318
Tube & Pipe Clip	317

### Fibre Reels and Guide

Coiling Clip	314
Chain Plate	314
Fibre Reels	315
Network Saddle	316

## FURNITURE FITTING

### Screw and Nut Cover Caps

Blind Rivet Caps	646
Bolt and Nut Protection Caps	650
Cover Caps	647-648
Grommet Nut	646
Nut Protection Caps	649
Rivet Head Knob	650
Screw Caps	649
Unicaps	648

## G PAGE NUMBER

### GASKETING AND ENCLOSURE ACCESSORIES

#### Gasketing

Bubble Gasket	528-538
Dual-Hard Self Adhesive	535
Dual Flipper Gasket	533
EMI Gasketing	536
EPDM Sponge Adhesive Seal	537
Glazing Gasketing	534
PVC Edge Protector	532

#### Lid Stays

Lid Stays	530
Drawer Slides	540

## H PAGE NUMBER

### HANDLES, KNOBS AND POSITIONING COMPONENTS

#### Clamping Handles

Clamping Handles	587-588
------------------	---------

#### Flush Handles

Hinged Handles	566
Low Profile Handles	567-568
Pull Handles	554-567
Recessed Flush Mount	567
Screw On Flush Handle	559-560
Rectangular Caps/Sleeves	570

#### Grips

Round or Rectangle Grips	593
Handle Grips	594
Round Finger Grasp	594

#### Hand Wheels and Knobs

Knobs	571-579
Hand Wheels	584
Socket Head Cap Screw	582
Four Lobed Thru Hole	585
Knobs for Socket Head Cap Screw	583-586

#### Index Plungers

Cam Levers	587
Index Plungers	592
Cam Plungers	592

#### Machine Handles

Pull Handles	559-560
--------------	---------

#### Pull Handles

Bridge Handles	554-555
Plastic Finger Carrying Handle	557
Bow Handle - Concealed Fixing	558
Machine Handles	559-560
Aluminium Handles	561

## HIGH TEMPERATURE MASKING

### EPDM and TPR Caps and Plugs

Flangeless Plugs	76, 86
High-Temperature Caps/Plugs	71-74, 75-77, 83-85
High-Temperature Ezecaps	83

## Mouse Tail PAGE NUMBER

Plugs with First-Thread Protection	83
------------------------------------	----

### Flexible PVC Caps and Plugs

Flexicaps	81
-----------	----

### Masking Tapes, Hooks and Bags

Discs	86
Masking Bags	87
Masking Square	87
Paper Tape	86
Polyester Tape	86
Stretch Fit Cover Caps	87

### Silicon Caps and Plugs

Blade Masking Cap	80
Cap with Flange	80
Flexitube	75
High-Temperature Caps/Plugs	75-77
High-Temperature Cone Caps/Plugs	75
High-Temperature Tubing	77
Hollow Thread Masking Plug	79
Mouse Tail	75
Multi Flange Plug	78
Pull Plug	78
Ribbed Ezecap	75
Tapered Plug with Handle	79
Washer Cap	80
Washer Pull Plug	80

## HYDRAULIC & PNEUMATIC PROTECTION

### Hose Clamps

Hose Clamps/Rings	50-51
-------------------	-------

### Hose Protection

Fire Protection Sleeve	43-44
Hose Protector	47
Spiralguard	46

### O-Rings and O-Rings Kits

O-Ring	53-60
--------	-------

### Specialist Hydraulic Caps and Plugs

Banjo Blots Caps	56
Banjo Union Caps/Plugs	56
Compression Fit Plugs	57
Hexagonal Caps	54
Hydraulic Quick Release Dust Caps/Plugs	55
O-Ring Face Seal Caps	53
Pull-Tab Hose Plug	54
SAE Butt Weld Covers	53
Side Release Plugs	57
Steel Clamp	52

## L PAGE NUMBER

### LED HARDWARE

### Lights Pipes and Lens Covers

Vertical Light Pipes	155
LED Lens Cover	155



## LED Spacers

LED Spacers	156-157
IR Receiver	157
LED Holder	158
LED Clips & Rings	160

## LOCKS, LATCHES, CATCHES AND HINGES

### Compression Locks

Budget Locks	444
Compression Latches	442-443
Compression Locks	446-460
HVAC Handles	445
Lift and Turn Lock	445
Push Button Latch	446
Push to Close Lock	471
Trigger Handle Latches	442

### Locks

Actuator Plate	417
Alternative Steel Cam	418
Cabinet Locks	424
Cam Locks	397, 415-416, 440
Cover Locks	397
Furniture Locks	472
Handle Locks	422-423, 426-435
Keys	446
Lift & Turn Cam Latches	430
Paddle Latch	427
Plastic Lock Nut	405
Plastic Lock with Finger Grips	405-406
Plastic Quarter Turn	406
Push Lock	437-438
Quarter Turn Accessories	414
Quarter Turn Blind Latch	417
Quarter Turn Latches	407
Quarter Turn Lock	401-402
Replacement Cam	415
Sliding Lock	428
Swing Handles	431-435
With Wing Knobs	403-404, 449

### Latches and Catches

Adjustable Latches	469
Catch and Strikers	471, 473
Catches	469-474
Draw Latch	461-463
Latch and Strikers	470-471

### Hinges

Adjustable Compression Hinge	517
Concealed Hinge	499, 502-504
Continuous Hinge	496
Corner Hinges	504
Flat Hinges	493
Heavy Duty Hinge	521
HVAC Hinge	520,522
Leaf Hinge	482-486
Lift-Off Hinge	463-464
Metal Leaf Hinges	476-479
Offset Hinge	515

Pin-On Hinge	481
Plastic Leaf Hinges	510
Quick Release Panel Door Hinge	499
Rolled Flag Hinge	506
Side Hinge	484-485
Stainless Steel Leaf Hinges	518-519
Stand-Off Hinge	471-472
Torque Hinge	516-517
Weld on Hinge	492-498

## P

PAGE NUMBER

### PIPE AND FLANGE PROTECTION

#### Flange Protection

Flange Protectors	66-68
Face Self-Adhesive Disc	68

#### Pipe Caps

Flexible Pipe Cap	64
Ribbed Pipe Plug	65

## S

PAGE NUMBER

### SLIDE BEARINGS AND VIBRATION MOUNTS

#### Slide Bearings

Slide Bearings	544-546
----------------	---------

#### Vibration Mounts

Vibration Grommet and Screw	551
Vibration Mounts	548-551

## T

PAGE NUMBER

### TUBE INSERTS, CONNECTORS AND FERRULES

#### Tube Inserts

Square Inserts	626-628
Round Inserts	628-631
Rectangular Inserts	632-634
Oval Inserts	635

#### Threaded Insert

Spring Threaded Insert	636
Spring Threaded Tube Connectors	637
All Metal Threaded Inserts	637
Threaded Inserts	638
Metal Threaded Inserts	639
Horizontal Inserts	640

#### Tube Connectors

Expanding Tube Connectors	640-641
Tube Connectors	640
Tube Locks	641

#### Ferrules

Ferrules	642-643
Square Gloss Caps	642



ACCESS HARDWARE  
APPLICATION GUIDE

# CABINET BUILDING WITH ACCESS HARDWARE

Our Essentials Guide to cabinet building using Access Hardware is designed to help you find the most appropriate solution for your project.

When building outdoor enclosures, HVAC units, generators and data cabinets there are many different access hardware components you can consider. The solutions you choose can help deliver cabinet security, controlled access, productive operation and a reduction in unnecessary repair costs. Explore our guide.

## HINGES

Often a full, restricted or controlled range of door motion is required when accessing your cabinet. Hinges allow you to vary this range of motion, no matter the door, frame or mounting area. Using the right hinge for your application can easily drive increased functionality for the end user.

We recommend:

- Torque hinge
- Metal leaf hinge
- Lift off hinge



Torque Hinge  
(Pg 517)

## LOCKS

Cabinets can be susceptible to tampering, ingress of dirt or liquids. Using a suitable lock enables peace of mind for you and your customers. A durable polyamide or corrosion resistant stainless steel will offer high potential IP ratings as well as strength, ensuring security is upheld.

We recommend:

- Quarter turn latch with spring
- T-Handle Heavy duty paddle lock
- T & L Handle lock



Quarter turn latch with spring  
(Pg 398)

## SWING HANDLES

For when security is paramount you need to be sure you can trust your cabinet is fully protected. Use a swing handle gear box with a three-point locking system to prevent tampering, keeping your cabinets fully operational.

We recommend:

- Lift & turn cam latches
- Off set compression lever latches
- Flush compression lever latches



Lift & turn cam latches  
(Pg 430)

## PULL HANDLES

Crucial when finishing your cabinet and maintaining quick and seamless functionality. Pull handles can offer ergonomic use and flush fitting installation to help users stay efficient and safe in a busy work space.

We recommend:

- Bridge Handles
- Stainless Steel Cabinet U Handle
- Stainless Steel Bolt on Flush Handle



Bridge Handles  
(Pg 554)

## LATCHES & CATCHES

When your application is in constant use you often require a secure yet easily accessed door. Maintain ease of access and save time in a busy environment using easy open latches and catches.

We recommend:

- Heavy duty magnetic catch
- Recessed Magnetic catches
- Lift and turn compression latch



Magnetic Catch  
(Pg 470)

For free samples, no-obligation quotes, advice about our products or to place an order, please contact us by phone, email or web. Refer to the back cover of this catalogue for contact information.

# CAPS AND PLUGS APPLICATION GUIDE

The Caps and Plugs edition of the Essentials Guide has been created to outline specific protection solutions for your project, in a number of key industrial manufacturing applications.

Many products that you manufacture are likely shipped to another location or customer, or simply moved along an assembly line as part of your production process. During these transits and end uses, it's important to protect vital parts to ensure efficient processes, safe use and reduced downtime. Explore our guide to see what we recommend when protecting your products.

## EQUIPMENT MANUFACTURING

Ensure smooth assembly and transit to your customers by protecting critical internal and external profiles from damage, maintaining quality and a timely delivery. Key equipment to protect includes enclosures, indoor and outdoor cabinets, HVAC units and generators.

Essentra recommends protecting with:



*Domed  
Blanking Plug  
(Pg 259)*



*Silicone Cap  
(Pg 76)*



## VEHICLES

In applications where precision is everything, it's essential to guard fuel lines from potential debris contamination and protect vital threads from damage during shipment and masking. Key vehicle parts to protect are diesel/petrol pumps, engines, specialist vehicle fittings, powertrains and brake systems.

Essentra recommends protecting with:



*Sealing Slottex Plug  
(Pg 33)*



*Tapered Cap  
(Pg 3)*

## METAL FABRICATION

Guarantee a professional finish every time by masking holes, studs and contact points during painting, blasting, and finishing processes. By protecting important areas of fabricated metal with easy-to-fit caps and plugs, you can successfully increase customer satisfaction and minimise recall of finished products. Key areas to guard include electrical contact points, threaded holes or studs and welding areas.

Essentra recommends protecting with:



*Masking Washer Plug  
(Pg 85)*



*Multi-Flex Caps  
(Pg 19)*

## HOSES & HYDRAULICS

Safe operation of devices using hydraulic fluid calls for specialist hose-fitting protection and coverage. The right cap or plug can help mitigate fluid spills and maintain hose integrity when looking to ensure constant machinery uptime and user safety. Key hydraulic parts that need safeguarding include grease nipples, DKO-compression fittings, fuel lines and banjo unions.

Essentra recommends protecting with:



*Hexagonal Caps  
(Pg 54)*



*Banjo Union Cap  
(Pg 56)*

For free samples, no-obligation quotes, advice about our products or to place an order, please contact us by phone, email or web. Refer to the back cover of this catalogue for contact information.

Wide range  
of quality  
products  
from stock

Hassle free  
and friendly  
service

Expert advice  
and technical  
support

## ASIA PACIFIC OFFICES

### AUSTRALIA

Tel : 1800 377 111  
sales@essentracomponents.com.au  
www.essentracomponents.com.au

### MALAYSIA

Tel : +603 5568 1988  
sales@essentracomponents.my  
www.essentracomponents.com.my

### THAILAND

Tel : +66 (2) 819 9501  
sales@essentracomponents.co.th  
www.essentracomponents.co.th

### CHINA

Tel : +86 400 679 3666  
Fax : +86 400 679 3677  
sales@essentracomponents.cn  
www.essentracomponents.cn

### SINGAPORE

Tel : +65 6841 3266  
sales@essentracomponents.com.sg  
www.essentracomponents.com.sg

### INDIA

Tel : +91 (0) 78997 39157  
sales@essentracomponents.co.in  
www.essentracomponents.co.in

### JAPAN

Tel : +81 45 321 2752  
sales@essentracomponents.jp  
www.essentracomponents.jp

### VIETNAM

sales@essentracomponents.vn  
www.essentracomponents.vn

Essentra facilities in Kidlington, Oxon are certified to:



Certificate Number 8293 ISO 50001  
ISO 9001  
ISO 14001  
OHSAS 18001

Essentra facilities in Ningbo, China are certified to:



ISO 9001  
IATF 16949  
ISO 14001  
OHSAS 18001

Essentra facilities in Rayong, Thailand are certified to:

