

COLOUR  
BLACK



© 2013 Essentra Components. All rights reserved.  
Registered in England, Company No. 547495.  
Registered Office: Essentra plc  
Langford Locks, Kidlington, Oxford, OX5 1HX

Condition of Sale can be found on our website: [essentra.com](http://essentra.com).

Essentra Components does not warrant that the files will be error free and may create new versions ("Upgrades") at any time, which may correct such errors. Essentra Components has no obligation to notify you of such upgrades. Any upgraded file will be published to the website, when it becomes available.

You are not permitted to load any of the files on to a network server for the purposes of distribution to one or more other computer(s) on that network or to effect such distribution. Essentra Components shall not be liable for any loss or damage whatsoever or however caused, arising directly or indirectly from the use of the files.

**UNCONTROLLED COPY**

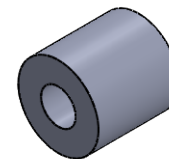
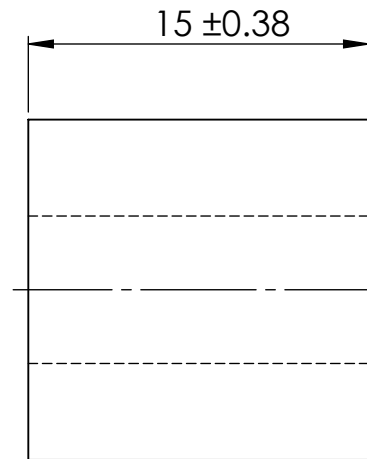
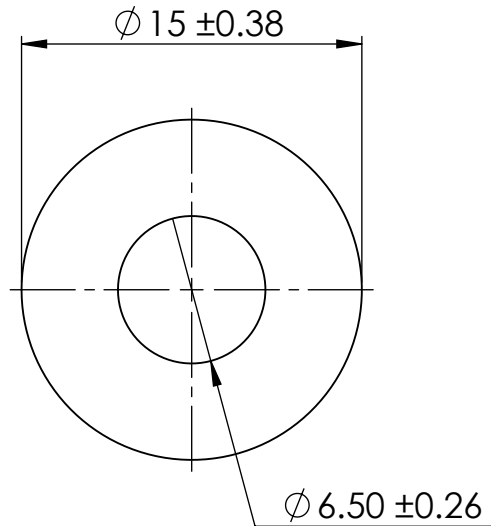

1:1

STATUS

**APPROVED DRAWING**

**UNLESS OTHERWISE STATED**

ALL DIMENSIONS IN mm

DO NOT SCALE

LINEAR TOLERANCE

THIRD ANGLE PROJECTION

SIZE	(0)	(0.0)	(0.00)
0-10mm	±0.5	±0.15	±0.10
>10-30	±0.5	±0.20	±0.15
>30-50	±0.5	±0.30	±0.20
>50-100	±0.8	±0.50	±0.25
>100-200	±1.5	±0.80	±0.40
>200-300	±2.0	±1.20	±0.80
>300-500	±3.0	±2.00	±1.00
>500	±5.0	±3.00	±1.50

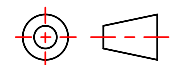

ANGULAR TOLERANCE ±0.5 DEGREES  
UNSPECIFIED RADII 0.25mm  
DRAFT ANGLE 0.5 DEGREES  
DIMENSIONS IN BRACKETS [ ] ARE  
IN INCHES FOR REFERENCE ONLY

CREATE DATE	18.06.2023	MATERIAL	HEAT STABILIZED
ITEM CODE	10204740	COLOUR	PA
LEGACY NUMBER	13ME080	FINISH	-

TITLE:  
**UNTHREADED SPACER  
6.5 MM 15.0 MM**

DWG. No.	10204740	SCALE	SHEET	ISSUE
		3:1	1 of 1	1