

UNCONTROLLED DOCUMENT

NOTES:  
DRIVE SIZE - #1

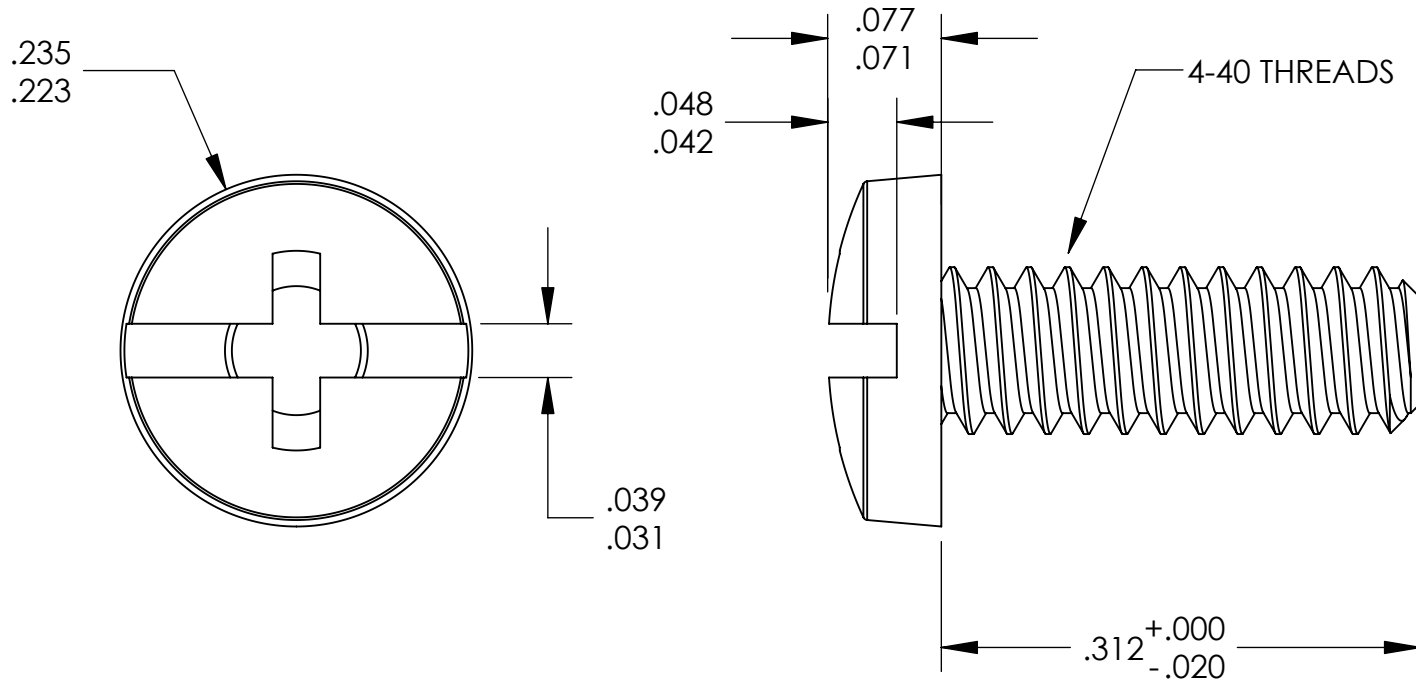

TOLERANCES UNLESS NOTED

- ±.005 ON DIMENSIONS THRU .625
- ±.008 ON DIMENSIONS .626 THRU 1.000
- ±.010 ON DIMENSIONS 1.001 THRU 1.500
- ±.015 ON DIMENSIONS LARGER THAN 1.500
- ±.015 ON FRACTIONAL DIMENSIONS

WE RESERVE THE RIGHT  
TO DISCONTINUE ITEMS,  
CHANGE SPECIFICATIONS  
OR DESIGN AT ANY TIME  
WITHOUT NOTICE AND  
WITHOUT INCURRING  
ANY OBLIGATIONS

PROPERTY OF		
<b>MICRO PLASTICS INC.</b>		
CATALOG DRAWING COMBO DRIVE BINDER MACHINE SCREW MICRO P/N 010440CD031 DWG. # 010440CD031 FILE SERVER\ENG\WEB		
MATERIAL:		6/6 NYLON
DATE	SCALE	<b>TA</b>
	8:1	