

© 2013 Essentra Components. All rights reserved.
 Registered in England, Company No. 547495.
 Registered Office: Essentra plc
 Langford Locks, Kidlington, Oxford, OX5 1HX

Condition of Sale can be found on our website: essentra.com.

Essentra Components does not warrant that the files will be error free and may create new versions ("Upgrades") at any time, which may correct such errors. Essentra Components has no obligation to notify you of such upgrades. Any upgraded file will be published to the website, when it becomes available.

You are not permitted to load any of the files on to a network server for the purposes of distribution to one or more other computer(s) on that network or to effect such distribution. Essentra Components shall not be liable for any loss or damage whatsoever or however caused, arising directly or indirectly from the use of the files.

UNCONTROLLED COPY

STATUS

APPROVED DRAWING

UNLESS OTHERWISE STATED

ALL DIMENSIONS IN mm

DO NOT SCALE

LINEAR TOLERANCE

THIRD ANGLE PROJECTION

SIZE	(0)	(0.0)	(0.00)
0-10mm	±0.5	±0.15	±0.10
>10-30	±0.5	±0.20	±0.15
>30-50	±0.5	±0.30	±0.20
>50-100	±0.8	±0.50	±0.25
>100-200	±1.5	±0.80	±0.40
>200-300	±2.0	±1.20	±0.80
>300-500	±3.0	±2.00	±1.00
>500	±5.0	±3.00	±1.50

ANGULAR TOLERANCE ±0.5 DEGREES
 UNSPECIFIED RADII 0.25mm
 DRAFT ANGLE 0.5 DEGREES
 DIMENSIONS IN BRACKETS [] ARE
 IN INCHES FOR REFERENCE ONLY

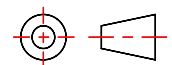

CREATE DATE	24.06.2023	MATERIAL	PA 66
ITEM CODE	10217351	COLOUR	-
LEGACY NUMBER	16FWRT500062	FINISH	-

TITLE:
RETAINING WASHER

DWG. No.	10217351	SCALE	SHEET	ISSUE
		2:1	1 of 1	1

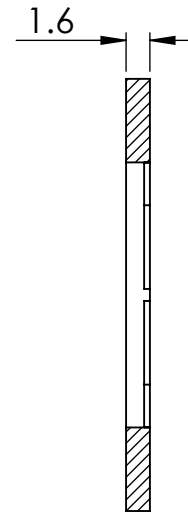
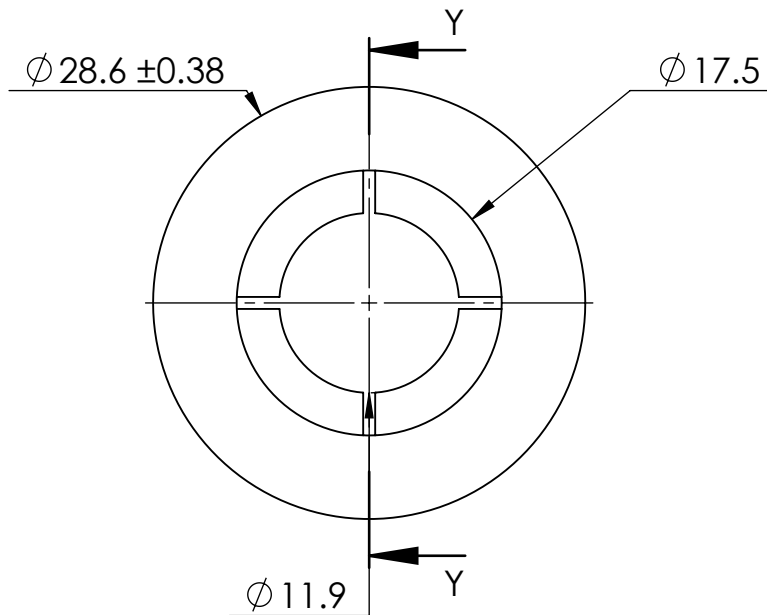

SECTION Y-Y

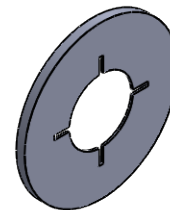

1:1