

UNCONTROLLED DOCUMENT

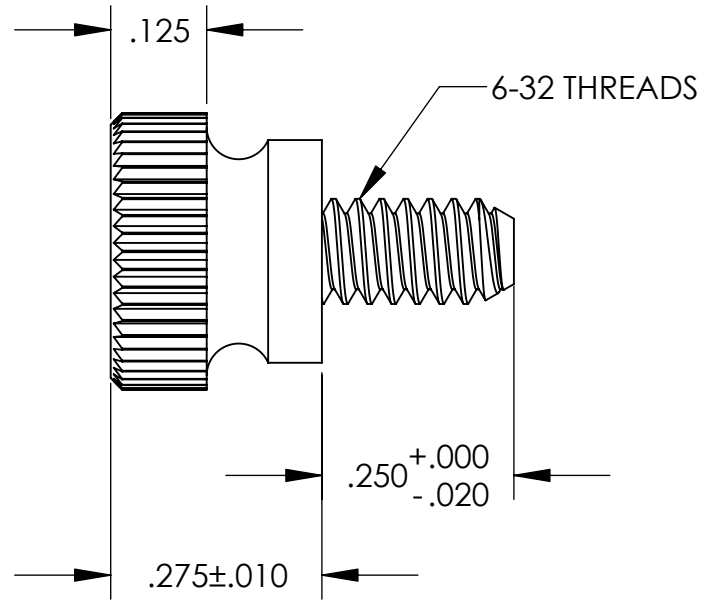
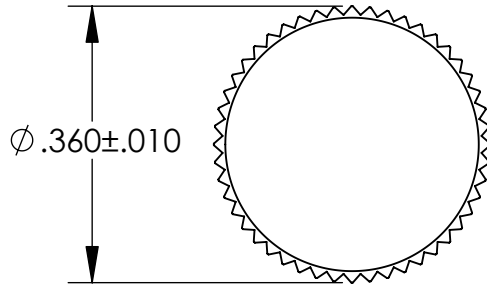

TOLERANCES UNLESS NOTED

- ±.005 ON DIMENSIONS THRU .625
- ±.008 ON DIMENSIONS .626 THRU 1.000
- ±.010 ON DIMENSIONS 1.001 THRU 1.500
- ±.015 ON DIMENSIONS LARGER THAN 1.500
- ±.015 ON FRACTIONAL DIMENSIONS

**WE RESERVE THE RIGHT
TO DISCONTINUE ITEMS,
CHANGE SPECIFICATIONS
OR DESIGN AT ANY TIME
WITHOUT NOTICE AND
WITHOUT INCURRING
ANY OBLIGATIONS**

PROPERTY OF
MICRO PLASTICS INC.

CATALOG DRAWING
KNURLED HEAD THUMB SCREW
MICRO P/N 090632025T
DWG. # 090632025T
FILE SERVER\ENG\WEB

MATERIAL: 6/6 NYLON

DATE

SCALE
4:1

JDD