

© 2011 Moss Plastic Parts Ltd. All rights reserved.
Registered in England, Company No. 547495.
Registered Office: Avebury House,
201-249 Avebury Boulevard, Milton Keynes, MK9 1AU

Condition of Sale can be found on our website:
mossexpress.com. Moss Express is a trading name of Moss
Plastic Parts Ltd.

Moss Plastic Parts Ltd does not warrant that the files will be
error free and may create new versions ("Upgrades") at any
time, which may correct such errors. Moss Plastic Parts Ltd
has no obligation to notify you of such upgrades. Any
upgraded file will be published to the website, when it
becomes available.

You are not permitted to load any of the files on to a network
server for the purposes of distribution to one or more other
computer(s) on that network or to effect such distribution.
Moss Plastic Parts Ltd shall not be liable for any loss or
damage whatsoever or however caused, arising directly or
indirectly from the use of the files.

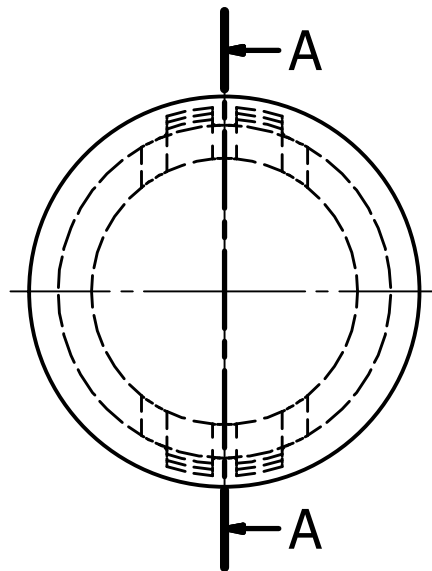

A-A (2 : 1)

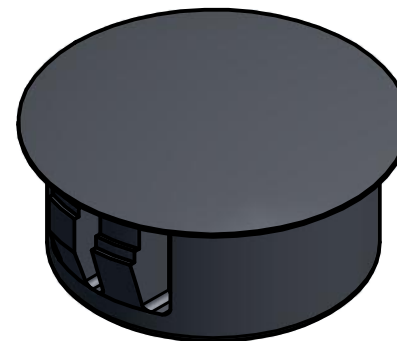
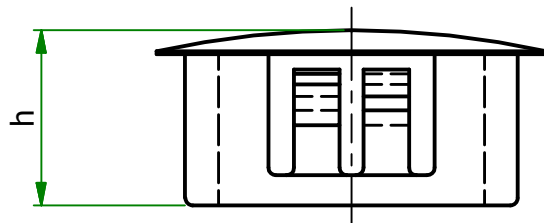
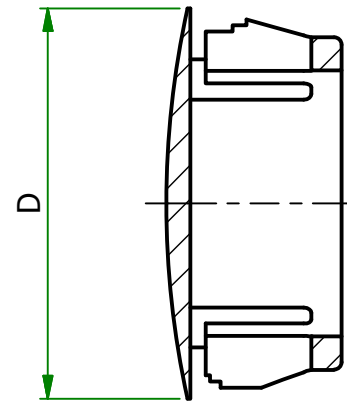

UNLESS OTHERWISE STATED

ALL DIMENSIONS IN mm				DO NOT SCALE	
LINEAR TOLERANCE				THIRD ANGLE PROJECTION	
SIZE	(0)	(0.0)	(0.00)		
0-10mm	±0.5	±0.15	±0.10		
10-30mm	±0.5	±0.20	±0.15		
30-50mm	±0.5	±0.30	±0.20		
50-100mm	±0.8	±0.50	±0.25		
100-200mm	±1.5	±0.80	±0.40		
200-300mm	±2.0	±1.20	±0.80		
300-500mm	±3.0	±2.00	±1.00	ANGULAR TOLERANCE ±0.5 DEGREES	
+500mm	±5.0	±3.00	±1.50	UNSPECIFIED RADII 0.25mm	
				DRAFT ANGLE 0.5 DEGREES	

ORG.SCALE 2:1

ITEM	COLOUR	MOUNTING HOLE DIA	MAX PANEL THICKNESS	D	h
PGM-10	Black	9.8	1.4	13.0	6.0

UNCONTROLLED

MATERIAL **NYLON**

ITEM No. **PGM-10**

TITLE **DOMED BLANKING PLUGS**

DWG.No. **SR1086**

ISSUE No. **1**