

UNCONTROLLED DOCUMENT

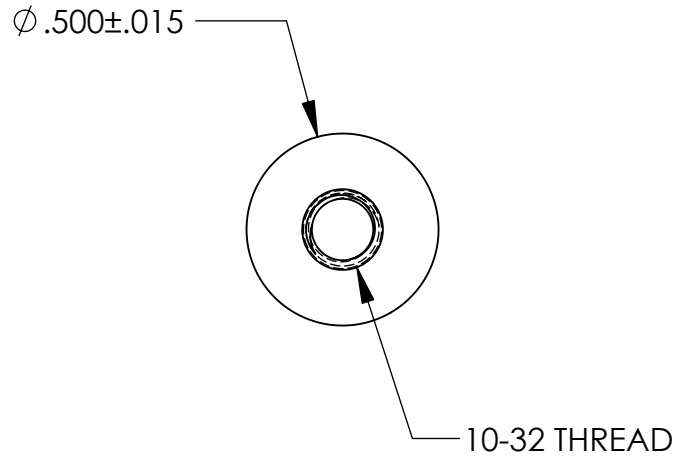

TOLERANCES UNLESS NOTED

- $\pm .005$ ON DIMENSIONS THRU $.625$
- $\pm .008$ ON DIMENSIONS $.626$ THRU 1.000
- $\pm .010$ ON DIMENSIONS 1.001 THRU 1.500
- $\pm .015$ ON DIMENSIONS LARGER THAN 1.500
- $\pm .015$ ON FRACTIONAL DIMENSIONS

**WE RESERVE THE RIGHT
TO DISCONTINUE ITEMS,
CHANGE SPECIFICATIONS
OR DESIGN AT ANY TIME
WITHOUT NOTICE AND
WITHOUT INCURRING
ANY OBLIGATIONS**

PROPERTY OF		
MICRO PLASTICS INC.		
CATALOG DRAWING TAPPED SPACER MICRO P/N 15TSP030 DWG. # 15TSP030 FILE SERVER\ENG\WEB		
MATERIAL:		6/6 NYLON
DATE	SCALE	TA
	2:1	