

UNCONTROLLED DOCUMENT

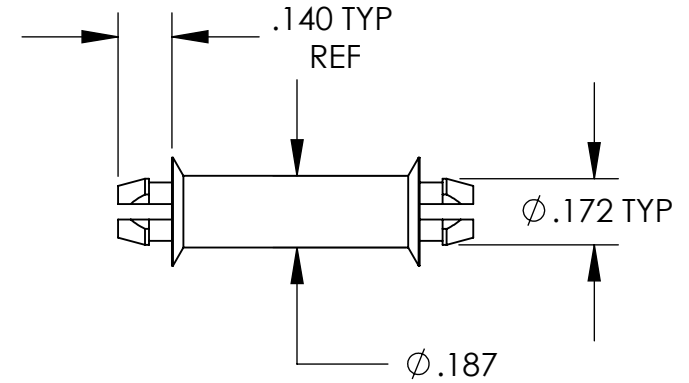
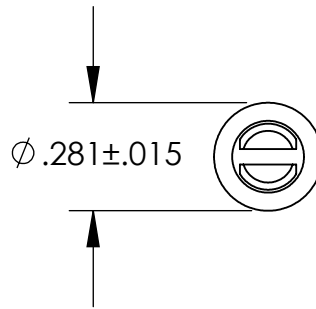
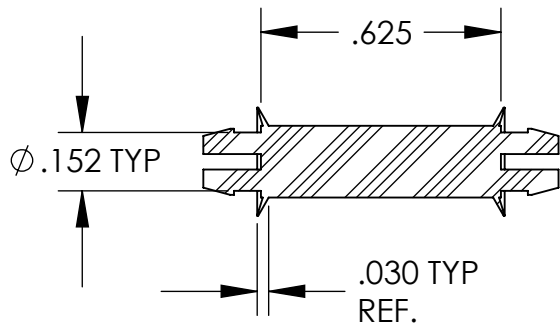

NOTES:
 BOTH ENDS FIT A .156 HOLE
 PANEL THICKNESS $.062 \pm .015$

TOLERANCES UNLESS NOTED

- $\pm .005$ ON DIMENSIONS THRU $.625$
- $\pm .008$ ON DIMENSIONS $.626$ THRU 1.000
- $\pm .010$ ON DIMENSIONS 1.001 THRU 1.500
- $\pm .015$ ON DIMENSIONS LARGER THAN 1.500
- $\pm .015$ ON FRACTIONAL DIMENSIONS

WE RESERVE THE RIGHT
 TO DISCONTINUE ITEMS,
 CHANGE SPECIFICATIONS
 OR DESIGN AT ANY TIME
 WITHOUT NOTICE AND
 WITHOUT INCURRING
 ANY OBLIGATIONS

PROPERTY OF		
MICRO PLASTICS INC.		
CATALOG DRAWING PCB SUPPORTS "DSP" SERIES MICRO P/N 27DSP00625 DWG. # 27DSP00625 FILE SERVER\ENG\WEB		
MATERIAL:		NYLON 6/6
DATE	SCALE	SD
	2:1	