

SCREW	COLOUR
#10	NATURAL



© 2013 Essentra Components. All rights reserved.
Registered in England, Company No. 547495.
Registered Office: Essentra plc
Langford Locks, Kidlington, Oxford, OX5 1HX

Condition of Sale can be found on our website: essentra.com.

Essentra Components does not warrant that the files will be error free and may create new versions ("Upgrades") at any time, which may correct such errors. Essentra Components has no obligation to notify you of such upgrades. Any upgraded file will be published to the website, when it becomes available.

You are not permitted to load any of the files on to a network server for the purposes of distribution to one or more other computer(s) on that network or to effect such distribution. Essentra Components shall not be liable for any loss or damage whatsoever or however caused, arising directly or indirectly from the use of the files.

UNCONTROLLED COPY

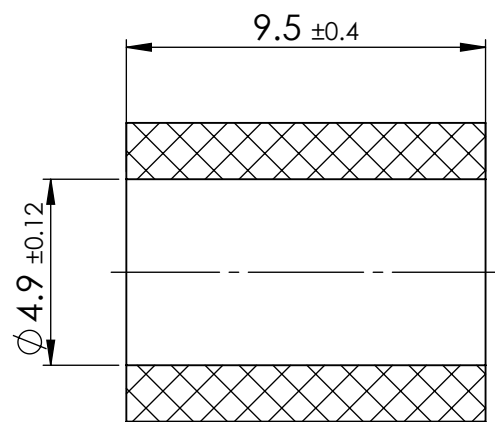
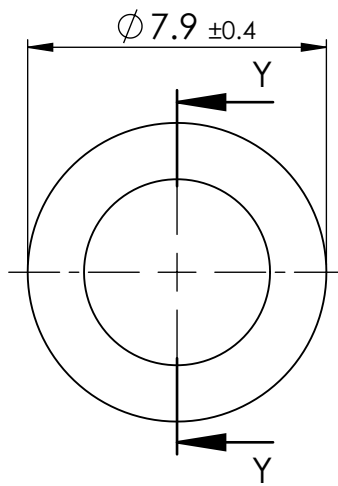

SECTION Y-Y

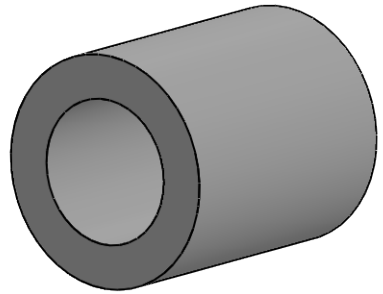

STATUS **APPROVED DRAWING**

UNLESS OTHERWISE STATED

ALL DIMENSIONS IN mm			DO NOT SCALE
LINEAR TOLERANCE			THIRD ANGLE PROJECTION
SIZE	(0)	(0.0)	(0.00)
0-10mm	±0.5	±0.15	±0.10
>10-30	±0.5	±0.20	±0.15
>30-50	±0.5	±0.30	±0.20
>50-100	±0.8	±0.50	±0.25
>100-200	±1.5	±0.80	±0.40
>200-300	±2.0	±1.20	±0.80
>300-500	±3.0	±2.00	±1.00
>500	±5.0	±3.00	±1.50
			ANGULAR TOLERANCE ±0.5 DEGREES
			UNSPECIFIED RADII 0.25mm
			DRAFT ANGLE 0.5 DEGREES
			DIMENSIONS IN BRACKETS [] ARE IN INCHES FOR REFERENCE ONLY

CREATE DATE	18.06.2023	MATERIAL	NYLON 6/6
ITEM CODE	10339206	COLOUR	-
LEGACY NUMBER	13SP110	FINISH	-

TITLE:
UNTHREADED SPACER
0.194 IN 0.313 IN

DWG. No.	10339206	SCALE	SHEET	ISSUE
		5:1	1 of 1	1